

Katalog części zamiennych K-723:2017

KATALOG CZĘŚCI ZAMIENNYCH  
Kotłów gazowych centralnego ogrzewania  
SPARE PARTS CATALOGUE  
For gas central heating boilers  
CATALOGO DEI PEZZI DI RICAMBIO  
per le caldaie a gas  
КАТАЛОГ ЗАПАСНЫХ ЧАСТЕЙ  
газовых отопительных котлов  
ERSATZTEILKATALOG  
für Gasheizungskessel

Dwufunkcyjnych  
Combi  
A.C.S. y C.C.  
Двухфункциональных  
Zweifunktion

typ / type / tipo/ типа / Typ  
**ECOCONDENS SLIM**

Jednofunkcyjnych  
System  
Solo C.C.  
Однофункциональных  
Einfunktion

typ / type / tipo/ типа/Typ  
**ECOCONDENS SLIM**

**termet** s.a.

ul. Długa 13, 58-160 Świebodzice  
Infolinia +48 74 85 60 801  
<http://www.termet.com.pl>  
e-mail: [export@termet.com.pl](mailto:export@termet.com.pl) [market@termet.com.pl](mailto:market@termet.com.pl)  
[termet@termet.com.pl](mailto:termet@termet.com.pl) [serwis@termet.com.pl](mailto:serwis@termet.com.pl)

WKD6040.00.00.00 - ECOCONDENS SLIM WKD PWM

rysunek/ drawing/ Zeichnung/ рисунок/ figura

R1

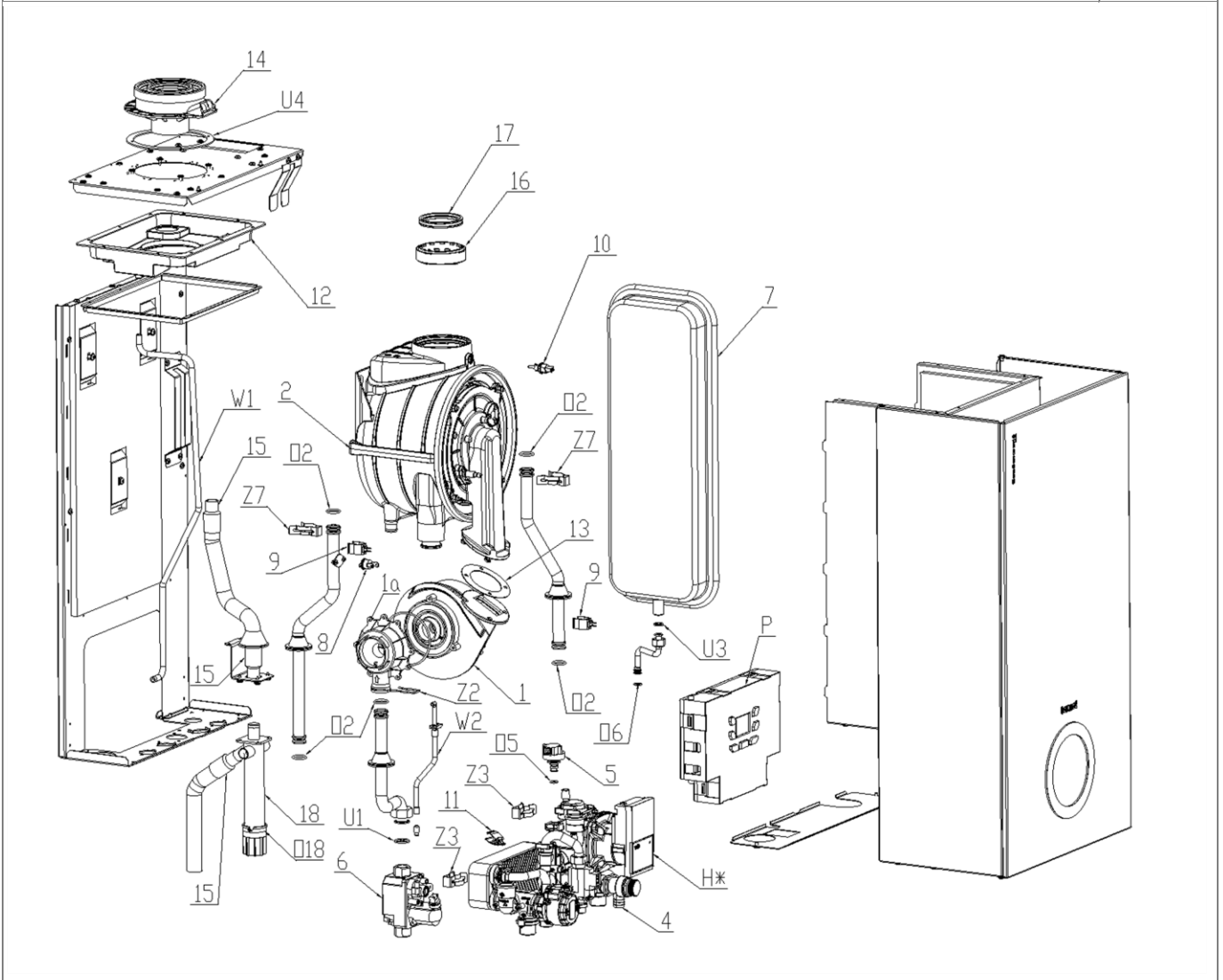

WKD5990.00.00.00 - ECOCONDENS SLIM WKD INT

rysunek/ drawing/ Zeichnung/ рисунок/ figura

R2

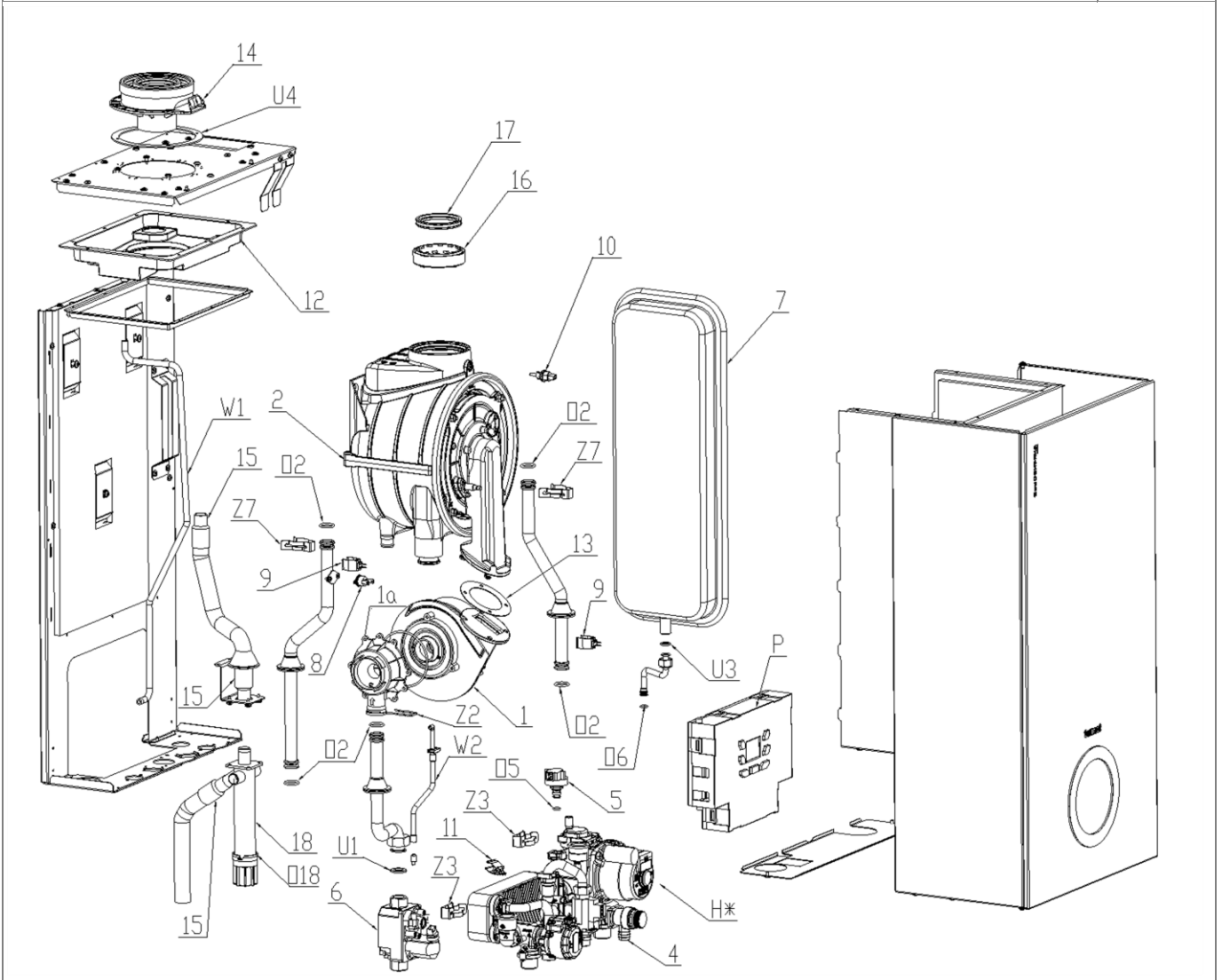

WKJ6010.00.00.00 - ECOCONDENS SLIM WKJ PWM

rysunek/ drawing/ Zeichnung/ рисунок/ figura

R3

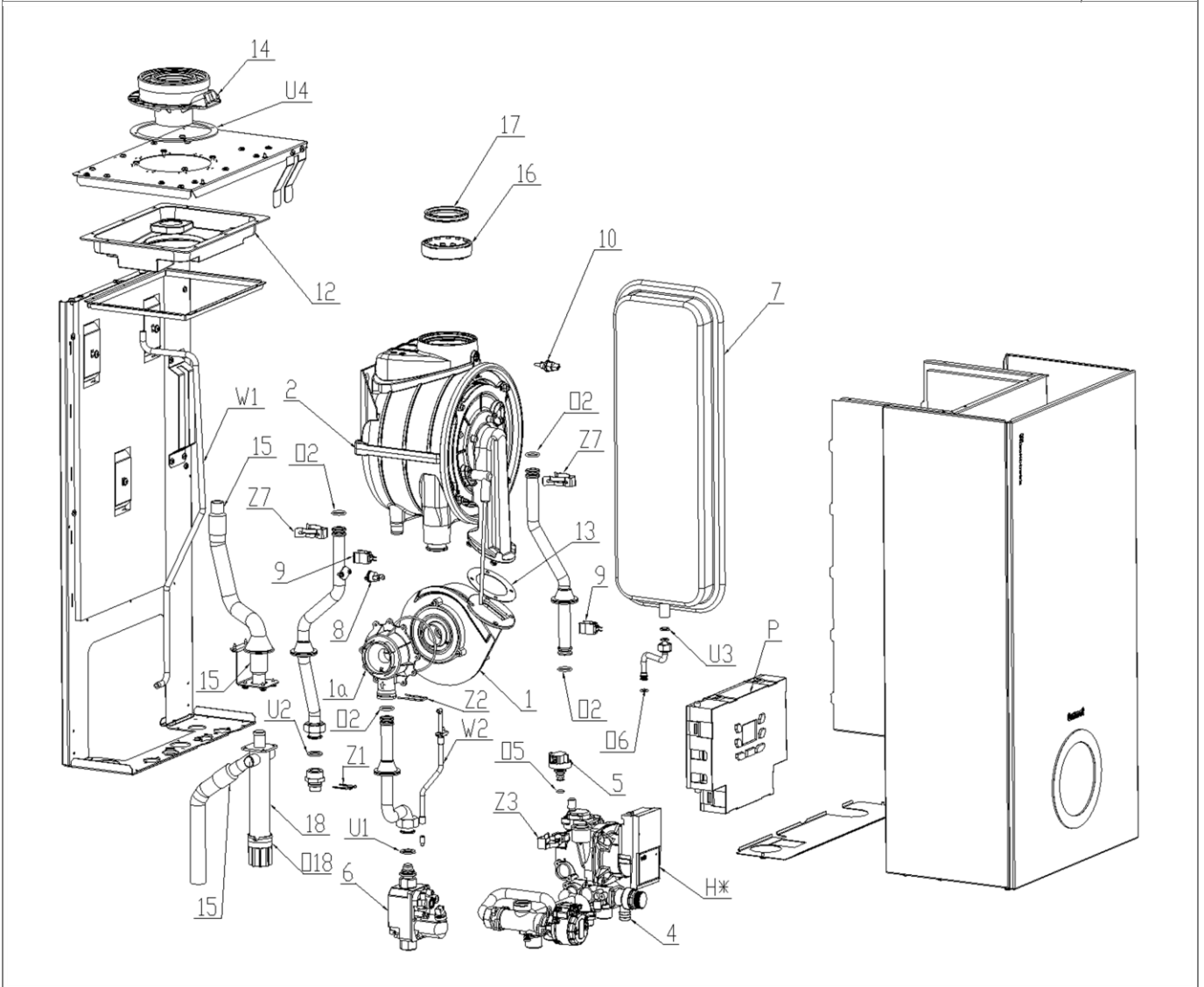

WKJ6000.00.00.00 - ECOCONDENS SLIM WKJ INT

rysunek/ drawing/ Zeichnung/ рисунок/ figura

R4

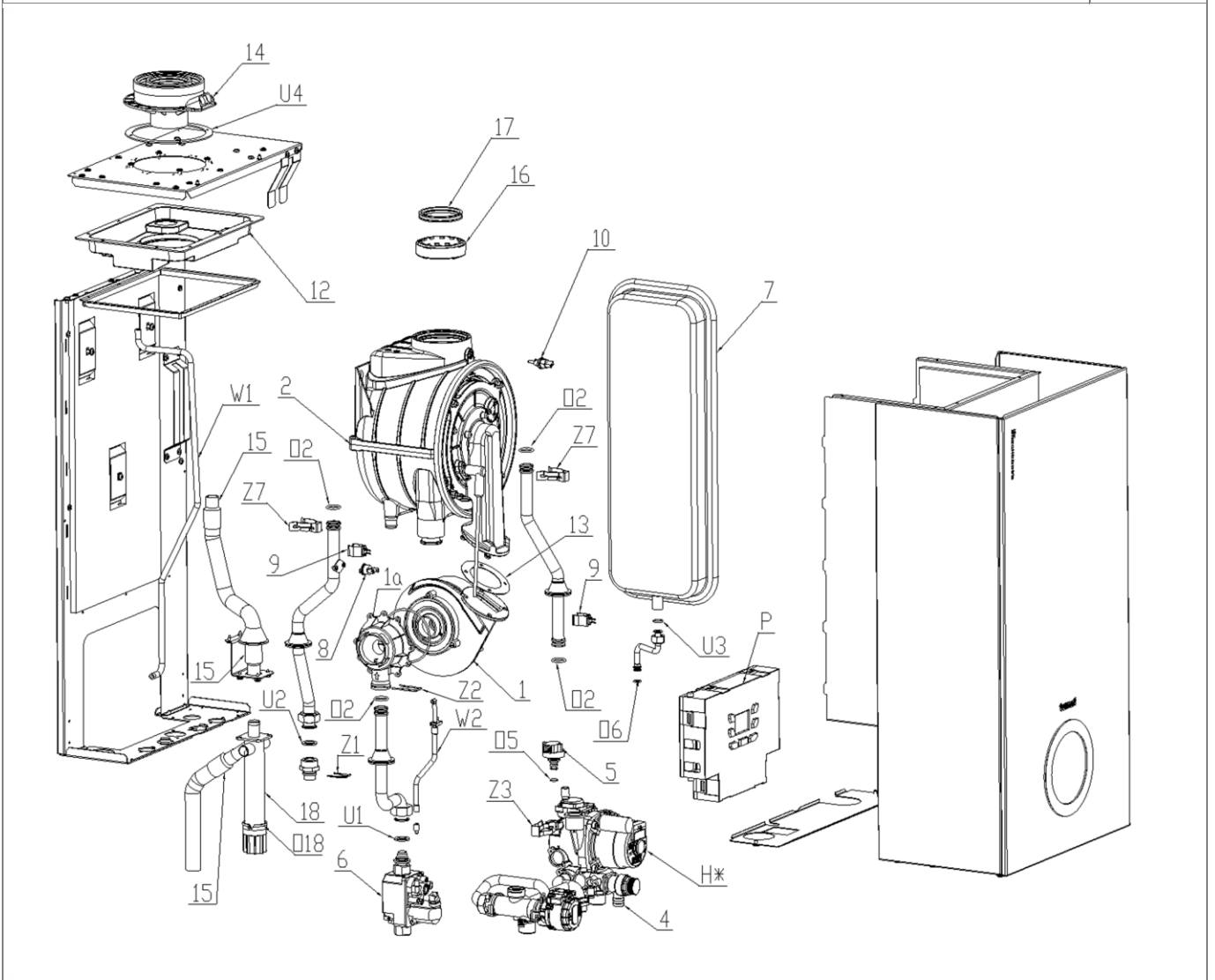

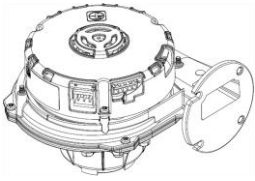
PL	<b>ZESPÓŁ WENTYLATORA</b>		
EN	<b>FAN KIT</b>		
DE	<b>LÜFTER-KIT</b>		
RU	<b>УЗЕЛ ВЕНТИЛЯТОРА</b>		
IT	<b>KIT VENTILATORE</b>		
	ZESP. WENTYLATORA		
<b>1</b>	odnośnik/ reference/ Referenz/ ссылка/ riferimento		
widok/ view/ Ansicht/ вид/ vista	indeks/ index/ Index/ индекс/ codice	szt./ pcs/ Stck./ штук/ Pz.	zastosowanie/ application/ Anwendung/ применение/ funzionalità del ricambio
	<b>Z4350070000</b> kod/ code/ Code/ код/ codice: <b>W940114230</b>	1	EcoCondens SLIM WKD INT EcoCondens SLIM WKD PWM EcoCondens SLIM WKJ INT EcoCondens SLIM WKJ PWM  Na rysunku/ In the picture/ Auf dem Bild/ На рисунке/ In figura: <b>R1, R2, R3, R4</b>
uwagi/ remarks/ Bemerkungen/ замечания/ commenti			
Uwaga: Ustawienia parametrów regulacyjnych według ISU. Note: Find regulation settings in service manual			

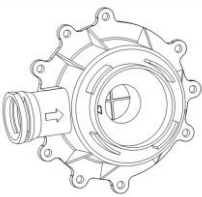
PL	<b>MIXER GAZ/POWIETRZE</b>		
EN	<b>GAS/AIR MIXER</b>		
DE	<b>GAS/LUFT-MISCHER</b>		
RU	<b>СМЕСИТЕЛЬ ГАЗ/ВОЗДУХ</b>		
IT	<b>MISCELATORE GAS-ARIA</b>		
	ZWĘZKA		
<b>1a</b>	odnośnik/ reference/ Referenz/ ссылка/ riferimento		
widok/ view/ Ansicht/ вид/ vista	indeks/ index/ Index/ индекс/ codice	szt./ pcs/ Stck./ штук/ Pz.	zastosowanie/ application/ Anwendung/ применение/ funzionalità del ricambio
	<b>Z4350070001</b> kod/ code/ Code/ код/ codice: <b>W990000630</b>  dysza/ nozzle/ Düse/ сопло/ ugello: <b>Ø 19</b>	1	EcoCondens SLIM WKD INT EcoCondens SLIM WKD PWM EcoCondens SLIM WKJ INT EcoCondens SLIM WKJ PWM
uwagi/ remarks/ Bemerkungen/ замечания/ commenti			
Uwaga: Ustawienia parametrów regulacyjnych według ISU. Note: Find regulation settings in service manual			

PL	<b>WYMIENNIK CIEPŁA</b>		
EN	<b>HEAT EXCHANGER</b>		
DE	<b>WÄRMETAUSCHER</b>		
RU	<b>ТЕПЛООБМЕННИК</b>		
IT	<b>SCAMBIATORE DI CALORE</b>		
	WYMIENNIK CIEPŁA SPALINY-WODA		
<b>2</b>	odnośnik/ reference/ Referenz/ ссылка/ riferimento		
widok/ view/ Ansicht/ вид/ vista	indeks/ index/ Index/ индекс/ codice	szt./ pcs/ Stck./ штук/ Pz.	zastosowanie/ application/ Anwendung/ применение/ funzionalità del ricambio
	<b>Z4390040000</b> typ/ type/ Тип/ тип/ tipo: <b>Condcell-S 20/25</b>  kod/ code/ Code/ код/ codice: <b>PCES20P002</b>	1	EcoCondens SLIM WKD INT EcoCondens SLIM WKD PWM EcoCondens SLIM WKJ INT EcoCondens SLIM WKJ PWM  Na rysunku/ In the picture/ Auf dem Bild/ На рисунке/ In figura: <b>R1, R2, R3, R4</b>

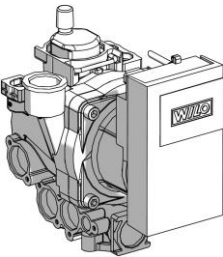
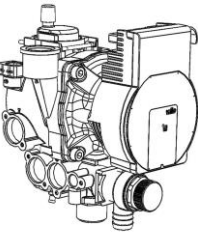
PL	<b>POMPA</b>		
EN	<b>PUMP</b>		
DE	<b>PUMPE</b>		
RU	<b>НАСОС</b>		
IT	<b>CIRCOLATORE</b>		
	POMPA CYRKULACYJNA YONOS PARA 15/7.0 PWM		
<b>3a</b>	odnośnik/ reference/ Referenz/ ссылка/ riferimento		
widok/ view/ Ansicht/ вид/ vista	indeks/ index/ Index/ индекс/ codice	szt./ pcs/ Stck./ штук/ Pz.	zastosowanie/ application/ Anwendung/ применение/ funzionalità del ricambio
	<b>Z2430010400</b> typ/ type/ Тип/ тип/ tipo: <b>Yonos PARA OTMSL 6B PWM 12</b>  kod/ code/ Code/ код/ codice: <b>21000 6065 16300</b>	1	EcoCondens SLIM WKD PWM EcoCondens SLIM WKJ PWM  Na rysunku/ In the picture/ Auf dem Bild/ На рисунке/ In figura: <b>H1, H3</b>
	uwagi/ remarks/ Bemerkungen/ замечания/ commenti  Do wyczerpania zapasów.		
	<b>Z4370710400</b> typ/ type/ Тип/ тип/ tipo: <b>Para 7 iPWM</b>	1	EcoCondens SLIM WKD PWM EcoCondens SLIM WKJ PWM
	uwagi/ remarks/ Bemerkungen/ замечания/ commenti  Wprowadzona w 2019r. Introduced in 2019.		

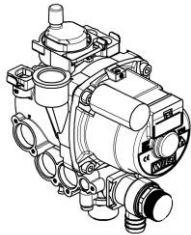
PL	<b>POMPA</b>			
EN	<b>PUMP</b>			
DE	<b>PUMPE</b>			
RU	<b>НАСОС</b>			
IT	<b>CIRCOLATORE</b>			
<b>POMPA CYRKULACYJNA OTMSL INT 15/5</b>				
<b>3b</b>	odnošnik/ reference/ Referenz/ ссылка/ riferimento			
widok/ view/ Ansicht/ вид/ vista	indeks/ index/ Index/ индекс/ codice	szt./ pcs/ Stck./ штук/ Pz.	zastosowanie/ application/ Anwendung/ применение/ funzionalità del ricambio	
	<b>Z1480500500</b> typ/ type/ Тип/ тип/ tipo: <b>CB.OTMSL INT 15/5-1</b> kod/ code/ Code/ код/ codice: <b>2100 6065 09310</b>	1	EcoCondens SLIM WKD INT EcoCondens SLIM WKJ INT  Na rysunku/ In the picture/ Auf dem Bild/ На рисунке/ In figura: <b>H2, H4</b>	

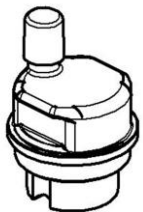
PL	<b>ODPOWIETRZNIK</b>			
EN	<b>AIR VENT</b>			
DE	<b>ENTLÜFTER</b>			
RU	<b>ВОЗДУХООДВОДЧИК</b>			
IT	<b>DISPOSITIVO DI SFIATO ARIA</b>			
<b>ODPOWIETRZNIK</b>				
<b>3.2</b>	odnošnik/ reference/ Referenz/ ссылка/ riferimento			
widok/ view/ Ansicht/ вид/ vista	indeks/ index/ Index/ индекс/ codice	szt./ pcs/ Stck./ штук/ Pz.	zastosowanie/ application/ Anwendung/ применение/ funzionalità del ricambio	
	<b>Z1480500421</b>	1	EcoCondens SLIM WKD INT EcoCondens SLIM WKD PWM EcoCondens SLIM WKJ INT EcoCondens SLIM WKJ PWM  Na rysunku/ In the picture/ Auf dem Bild/ На рисунке/ In figura: <b>H1, H2, H3, H4</b>	



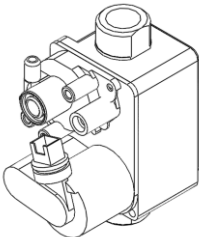

PL	<b>ZAWÓR BEZPIECZEŃSTWA</b>		
EN	<b>SAFETY VALVE</b>		
DE	<b>SICHERHEITSVENTIL</b>		
RU	<b>ПРЕДОХРАНИТЕЛЬНЫЙ КЛАПАН</b>		
IT	<b>VALVOLA DI SICUREZZA</b>		
	<b>ZAWÓR BEZPIECZEŃSTWA 3BAR</b>		
<b>4</b>	odnošnik/ reference/ Referenz/ ссылка/ riferimento		
widok/ view/ Ansicht/ вид/ vista	indeks/ index/ Index/ индекс/ codice	szt./ pcs/ Stck./ штук/ Pz.	zastosowanie/ application/ Anwendung/ применение/ funzionalità del ricambio
	<b>Z0700010600</b> typ/ type/ Тип/ тип/ tipo: <b>PN-10</b>	1	EcoCondens SLIM WKD INT EcoCondens SLIM WKD PWM EcoCondens SLIM WKJ INT EcoCondens SLIM WKJ PWM  Na rysunku/ In the picture/ Auf dem Bild/ На рисунке/ In figura: <b>H1, H2, H3, H4, R1, R2, R3, R4</b>

PL	<b>PRZETWORNIK CIŚNIENIA</b>		
EN	<b>PRESSURE TRANSDUCER</b>		
DE	<b>DRUCKAUFNEHMER</b>		
RU	<b>ПРЕОБРАЗОВАТЕЛЬ ДАВЛЕНИЯ</b>		
IT	<b>TRASDUTTORE DI PRESSIONE</b>		
	<b>PRZETWORNIK CIŚNIENIA</b>		
<b>5</b>	odnošnik/ reference/ Referenz/ ссылка/ riferimento		
widok/ view/ Ansicht/ вид/ vista	indeks/ index/ Index/ индекс/ codice	szt./ pcs/ Stck./ штук/ Pz.	zastosowanie/ application/ Anwendung/ применение/ funzionalità del ricambio
	<b>Z1320480000</b> typ/ type/ Тип/ тип/ tipo: <b>TCHA00 5V</b> lub/ or/ oder/ или/ o  <b>Z1320490000</b> typ/ type/ Тип/ тип/ tipo: <b>5260 AAOO 5V</b>	1	EcoCondens SLIM WKD INT EcoCondens SLIM WKD PWM EcoCondens SLIM WKJ INT EcoCondens SLIM WKJ PWM  Na rysunku/ In the picture/ Auf dem Bild/ На рисунке/ In figura: <b>H3, H4, R1, R2, R3, R4</b>

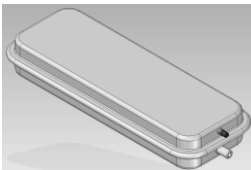
PL	<b>ZAWÓR GAZOWY</b>			
EN	<b>GAS VALVE</b>			
DE	<b>GASVENTIL</b>			
RU	<b>ГАЗОВЫЙ КЛАПАН</b>			
IT	<b>VALVOLA GAS</b>			
	<b>ZAWÓR GAZOWY</b>			
<b>6</b>	odnošnik/ reference/ Referenz/ ссылка/ riferimento			
widok/ view/ Ansicht/ вид/ vista	indeks/ index/ Index/ индекс/ codice	szt./ pcs/ Stck./ штук/ Pz.	zastosowanie/ application/ Anwendung/ применение/ funzionalità del ricambio	
	<b>Z4830060000</b> typ/ type/ Тип/ тип/ tipo: <b>VK8205VE1003</b>	1	EcoCondens SLIM WKD INT EcoCondens SLIM WKD PWM EcoCondens SLIM WKJ INT EcoCondens SLIM WKJ PWM  Na rysunku/ In the picture/ Auf dem Bild/ На рисунке/ In figura: <b>R1, R2, R3, R4</b>	

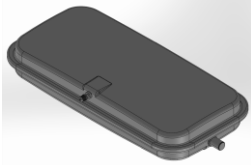
PL	<b>NACZYNIĘ WYRÓWNAWCZE</b>			
EN	<b>EXPANSION VESSEL</b>			
DE	<b>AUSDEHNUNGSGEFÄß</b>			
RU	<b>РАСШИРИТЕЛЬНЫЙ БАК</b>			
IT	<b>VASO D'ESPANSIONE</b>			
	<b>NACZYNIĘ WZBIORCZE 6L CIMM</b>			
<b>7</b>	odnošnik/ reference/ Referenz/ ссылка/ riferimento			
widok/ view/ Ansicht/ вид/ vista	indeks/ index/ Index/ индекс/ codice	szt./ pcs/ Stck./ штук/ Pz.	zastosowanie/ application/ Anwendung/ применение/ funzionalità del ricambio	
	<b>Z2650080000</b> typ/ type/ Тип/ тип/ tipo: <b>RP/R7 6 L</b>  kod/ code/ Code/ код/ codice: <b>9106/TER</b>	1	EcoCondens SLIM WKD INT EcoCondens SLIM WKD PWM EcoCondens SLIM WKJ INT EcoCondens SLIM WKJ PWM  Na rysunku/ In the picture/ Auf dem Bild/ На рисунке/ In figura: <b>R1, R2, R3, R4</b>	

PL	<b>NACZYNIĘ WYRÓWNAWCZE</b>		
EN	<b>EXPANSION VESSEL</b>		
DE	<b>AUSDEHNUNGSGEFÄß</b>		
RU	<b>РАСШИРИТЕЛЬНЫЙ БАК</b>		
IT	<b>VASO D'ESPANSIONE</b>		
	<b>NACZYNIĘ WZBIORCZE 8L CIMM</b>		
<b>7a</b>	odnośnik/ reference/ Referenz/ ссылка/ riferimento		
widok/ view/ Ansicht/ вид/ vista	indeks/ index/ Index/ индекс/ codice	szt./ pcs/ Stck./ штук/ Pz.	zastosowanie/ application/ Anwendung/ применение/ funzionalità del ricambio
	<b>Z6040080000</b> typ/ type/ Тип/ тип/ tipo: <b>RP 220 lt.8 G 3/8"x28</b> <b>valv.90</b>  kod/ code/ Code/ код/ codice: <b>9208/TER</b>	1	EcoCondens SLIM WKD INT EcoCondens SLIM WKD PWM EcoCondens SLIM WKJ INT EcoCondens SLIM WKJ PWM  Na rysunku/ In the picture/ Auf dem Bild/ На рисунке/ In figura: <b>R1, R2, R3, R4</b>
	uwagi/ remarks/ Bemerkungen/ замечания/ commenti  Dla kotłów wyprodukowanych od 12.2019		

PL	<b>OGRANICZNIK TEMPERATURY</b>		
EN	<b>TEMPERATURE LIMITER</b>		
DE	<b>TEMPERATURBEGRENZER</b>		
RU	<b>ОГРАНИЧИТЕЛЬ ТЕМПЕРАТУРЫ</b>		
IT	<b>TERMOSTATO LIMITE</b>		
	<b>OGRANICZNIK TEMPERATURY 95°C</b>		
<b>8</b>	odnośnik/ reference/ Referenz/ ссылка/ riferimento		
widok/ view/ Ansicht/ вид/ vista	indeks/ index/ Index/ индекс/ codice	szt./ pcs/ Stck./ штук/ Pz.	zastosowanie/ application/ Anwendung/ применение/ funzionalità del ricambio
	<b>Z0560712100</b> typ/ type/ Тип/ тип/ tipo: <b>2455R, 95°C</b> lub/ or/ oder/ или/ o  <b>Z0560702100</b> typ/ type/ Тип/ тип/ tipo: <b>36TVZE21</b>  kod/ code/ Code/ код/ codice: <b>506426</b>	1	EcoCondens SLIM WKD INT EcoCondens SLIM WKD PWM EcoCondens SLIM WKJ INT EcoCondens SLIM WKJ PWM  Na rysunku/ In the picture/ Auf dem Bild/ На рисунке/ In figura: <b>R1, R2, R3, R4</b>

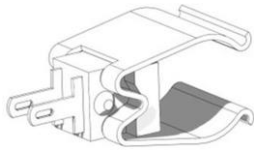
PL	<b>CZUJNIK NTC STYKOWY</b>		
EN	<b>CONTACT NTC SENSOR</b>		
DE	<b>KONTAKT NTC-SENSOR</b>		
RU	<b>ДАТЧИК NTC КОНТАКТНЫЙ</b>		
IT	<b>SENSORE NTC A CONTATTO</b>		
	<b>CZUJNIK NTC STYKOWY</b>		
<b>9</b>	odnošnik/ reference/ Referenz/ ссылка/ riferimento		
widok/ view/ Ansicht/ вид/ vista	indeks/ index/ Index/ индекс/ codice	szt./ pcs/ Stck./ штук/ Pz.	zastosowanie/ application/ Anwendung/ применение/ funzionalità del ricambio
	<p><b>Z1780009000</b></p> <p>typ/ type/ Тип/ тип/ tipo: <b>ß=3977; Ø18</b></p> <p>kod/ code/ Code/ код/ codice: <b>T7335D1016</b> lub/ or/ oder/ или/ o</p> <p><b>Z1620009000</b></p> <p>typ/ type/ Тип/ тип/ tipo: <b>R/241 02 01/0; ß=3975; Ø18÷25</b> lub/ or/ oder/ или/ o</p> <p><b>Z1460009000</b></p> <p>typ/ type/ Тип/ тип/ tipo: <b>TR01BJ1REV, ß=3977; Ø18</b></p>	2	<p>EcoCondens SLIM WKD INT EcoCondens SLIM WKD PWM EcoCondens SLIM WKJ INT EcoCondens SLIM WKJ PWM</p> <p>Na rysunku/ In the picture/ Auf dem Bild/ На рисунке/ In figura: <b>R1, R2, R3, R4</b></p>
uwagi/ remarks/ Bemerkungen/ замечания/ commenti			
2 szt. dla ECOCONDENS SLIM PWM 1 szt. dla ECOCONDENS SLIM INT			
Opakowanie zawiera/ The package contains/ Das Paket enthält/ Упаковка содержит/ La confezione include: 1 szt./ pcs/ Stck./ штук/ Pz.			

PL	<b>BEZPIECZNIK TERMICZNY</b>		
EN	<b>THERMAL FUSE</b>		
DE	<b>THERMOSICHERUNG</b>		
RU	<b>ТЕРМИЧЕСКИЙ ПРЕДОХРАНИТЕЛЬ</b>		
IT	<b>FUSIBILE TERMICO</b>		
	<b>BEZPIECZNIK TERMICZNY</b>		
<b>10</b>	odnošnik/ reference/ Referenz/ ссылка/ riferimento		
widok/ view/ Ansicht/ вид/ vista	indeks/ index/ Index/ индекс/ codice	szt./ pcs/ Stck./ штук/ Pz.	zastosowanie/ application/ Anwendung/ применение/ funzionalità del ricambio
	<p><b>Z4350040500</b></p> <p>typ/ type/ Тип/ тип/ tipo: <b>115C</b></p> <p>kod/ code/ Code/ код/ codice: <b>9863521</b></p>	1	<p>EcoCondens SLIM WKD INT EcoCondens SLIM WKD PWM EcoCondens SLIM WKJ INT EcoCondens SLIM WKJ PWM</p> <p>Na rysunku/ In the picture/ Auf dem Bild/ На рисунке/ In figura: <b>R1, R2, R3, R4</b></p>

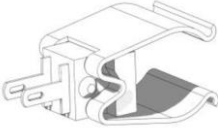
PL	<b>CZUJNIK NTC STYKOWY</b>		
EN	<b>CONTACT NTC SENSOR</b>		
DE	<b>KONTAKT NTC-SENSOR</b>		
RU	<b>ДАТЧИК NTC КОНТАКТНЫЙ</b>		
IT	<b>SENSORE NTC A CONTATTO</b>		
	CZUJNIK NTC STYKOWY		
<b>11</b>	odnošnik/ reference/ Referenz/ ссылка/ riferimento		
widok/ view/ Ansicht/ вид/ vista	indeks/ index/ Index/ индекс/ codice	szt./ pcs/ Stck./ штук/ Pz.	zastosowanie/ application/ Anwendung/ применение/ funzionalità del ricambio
	<p><b>Z1780009100</b></p> <p>typ/ type/ Тип/ тип/ tipo:  <b>В=3977; Ø14</b></p> <p>kod/ code/ Code/ код/ codice:  <b>T7335D1008</b>  lub/ or/ oder/ или/ o</p> <p><b>Z1620009100</b></p> <p>typ/ type/ Тип/ тип/ tipo:  <b>R/241 02 01/1; В=3975;  Ø13÷16</b>  lub/ or/ oder/ или/ o</p> <p><b>Z1480009100</b></p> <p>typ/ type/ Тип/ тип/ tipo:  <b>В=3977; Ø14</b></p>	1	<p>EcoCondens SLIM WKD INT  EcoCondens SLIM WKD PWM</p> <p>Na rysunku/ In the picture/ Auf dem Bild/ На рисунке/ In figura:  <b>R1, R3</b></p>

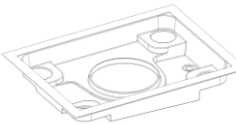
PL	<b>PODZESPÓŁ OCIEKACZA</b>		
EN	<b>CONDENSATE DRAIN TRAY KIT</b>		
DE	<b>KONDENSATWANNE-SET</b>		
RU	<b>СБОРНИК ДЛЯ КОНДЕНСАТА</b>		
IT	<b>KIT VASCHETTA RACCOGLI CONDENSA</b>		
	PODZ. OCIEKACZA		
<b>12</b>	odnošnik/ reference/ Referenz/ ссылка/ riferimento		
widok/ view/ Ansicht/ вид/ vista	indeks/ index/ Index/ индекс/ codice	szt./ pcs/ Stck./ штук/ Pz.	zastosowanie/ application/ Anwendung/ применение/ funzionalità del ricambio
	<b>Z4780000900</b>	1	<p>EcoCondens SLIM WKD INT  EcoCondens SLIM WKD PWM  EcoCondens SLIM WKJ INT  EcoCondens SLIM WKJ PWM</p> <p>Na rysunku/ In the picture/ Auf dem Bild/ На рисунке/ In figura:  <b>R1, R2, R3, R4</b></p>

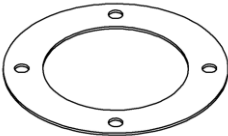
PL	<b>USZCZELKA WENTYLATORA</b>		
EN	<b>FAN GASKET</b>		
DE	<b>LÜFTERDICHTUNG</b>		
RU	<b>ПРОКЛАДКА ВЕНТИЛЯТОРА</b>		
IT	<b>GUARNIZIONE VENTILATORE</b>		
	USZCZELKA WENTYLATORA		
<b>13</b>	odnośnik/ reference/ Referenz/ ссылка/ riferimento		
widok/ view/ Ansicht/ вид/ vista	indeks/ index/ Index/ индекс/ codice	szt./ pcs/ Stck./ штук/ Pz.	zastosowanie/ application/ Anwendung/ применение/ funzionalità del ricambio
	<b>Z0720050002</b>	1	EcoCondens SLIM WKD INT EcoCondens SLIM WKD PWM EcoCondens SLIM WKJ INT EcoCondens SLIM WKJ PWM  Na rysunku/ In the picture/ Auf dem Bild/ На рисунке/ In figura: <b>R1, R2, R3, R4</b>
uwagi/ remarks/ Bemerkungen/ замечания/ commenti			
Opakowanie zawiera/ The package contains/ Das Paket enthält/ Упаковка содержит/ La confezione include: 10 szt./ pcs/ Stck./ штук/ Pz.			

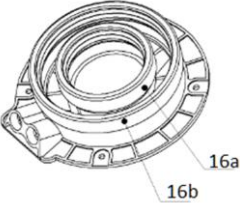
PL	<b>PODZESPÓŁ ADAPTERA SPALIN</b>		
EN	<b>FLUE GAS ADAPTER KIT</b>		
DE	<b>ABGASADAPTERBAUGRUPPE</b>		
RU	<b>ПОДУЗЕЛ АДАПТЕРА ПРОДУКТОВ СГОРАНИЯ</b>		
IT	<b>KIT ADATTORE PER SCARICO FUMI</b>		
	PODZ. ADAPTERA SPALIN 60/100		
<b>14</b>	odnośnik/ reference/ Referenz/ ссылка/ riferimento		
widok/ view/ Ansicht/ вид/ vista	indeks/ index/ Index/ индекс/ codice	szt./ pcs/ Stck./ штук/ Pz.	zastosowanie/ application/ Anwendung/ применение/ funzionalità del ricambio
	<b>Z2730900100</b>	1	EcoCondens SLIM WKD INT EcoCondens SLIM WKD PWM EcoCondens SLIM WKJ INT EcoCondens SLIM WKJ PWM  Na rysunku/ In the picture/ Auf dem Bild/ На рисунке/ In figura: <b>R1, R2, R3, R4</b>

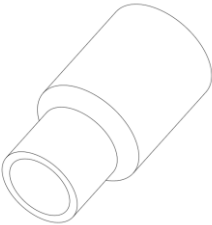
PL	<b>ŁĄCZNIK GUMOWY</b>		
EN	<b>RUBBER CONNECTOR</b>		
DE	<b>GUMMIVERBINDER</b>		
RU	<b>МУФТА РЕЗИНОВАЯ</b>		
IT	<b>CONNETTORE IN GOMMA</b>		
	ŁĄCZNIK GUMOWY		
<b>15</b>	odnośnik/ reference/ Referenz/ ссылка/ riferimento		
widok/ view/ Ansicht/ вид/ vista	indeks/ index/ Index/ индекс/ codice	szt./ pcs/ Stck./ штук/ Pz.	zastosowanie/ application/ Anwendung/ применение/ funzionalità del ricambio
	<b>Z265000028</b>	3	EcoCondens SLIM WKD INT EcoCondens SLIM WKD PWM EcoCondens SLIM WKJ INT EcoCondens SLIM WKJ PWM  Na rysunku/ In the picture/ Auf dem Bild/ На рисунке/ In figura: <b>R1, R2, R3, R4</b>
	uwagi/ remarks/ Bemerkungen/ замечания/ commenti  Opakowanie zawiera/ The package contains/ Das Paket enthält/ Упаковка содержит/ La confezione include: 2 szt./ pcs/ Stck./ штук/ Pz.		

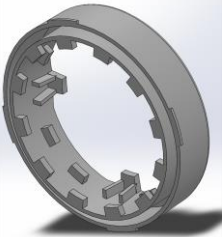
PL	<b>ADAPTER SPALIN Z USZCZELKĄ</b>		
EN	<b>FLUE GAS ADAPTER WITH GASKET</b>		
DE	<b>ABGASADAPTER MIT DICHTUNG</b>		
RU	<b>АДАПТЕР ПРОДУКТОВ СГОРАНИЯ С ПРОКЛАДКОЙ</b>		
IT	<b>ADATTATORE PER SCARICO FUMI CON GUARNIZIONE</b>		
	ADAPTER SPALIN 80/60 Z USZCZELKĄ		
<b>16</b>	odnośnik/ reference/ Referenz/ ссылка/ riferimento		
widok/ view/ Ansicht/ вид/ vista	indeks/ index/ Index/ индекс/ codice	szt./ pcs/ Stck./ штук/ Pz.	zastosowanie/ application/ Anwendung/ применение/ funzionalità del ricambio
	<b>Z0720040013</b>	1	EcoCondens SLIM WKD INT EcoCondens SLIM WKD PWM EcoCondens SLIM WKJ INT EcoCondens SLIM WKJ PWM  Na rysunku/ In the picture/ Auf dem Bild/ На рисунке/ In figura: <b>R1, R2, R3, R4</b>

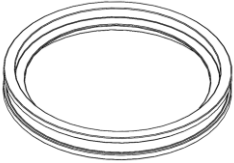
PL	<b>USZCZELKA WYLOTU SPALIN</b>		
EN	<b>FLUE OUTLET GASKET</b>		
DE	<b>RAUCHABZUGSDICHTUNG</b>		
RU	<b>ПРОКЛАДКА ВЫХОДА ПРОДУКТОВ СГОРАНИЯ</b>		
IT	<b>GUARNIZIONE USCITA FUMI</b>		
	<b>USZCZELKA ADAPTERA SPALIN</b>		
<b>17</b>	odnošnik/ reference/ Referenz/ ссылка/ riferimento		
widok/ view/ Ansicht/ вид/ vista	indeks/ index/ Index/ индекс/ codice	szt./ pcs/ Stck./ штук/ Pz.	zastosowanie/ application/ Anwendung/ применение/ funzionalità del ricambio
	<b>Z0720040014</b>	1	EcoCondens SLIM WKD INT EcoCondens SLIM WKD PWM EcoCondens SLIM WKJ INT EcoCondens SLIM WKJ PWM  Na rysunku/ In the picture/ Auf dem Bild/ На рисунке/ In figura: <b>R1, R2, R3, R4</b>

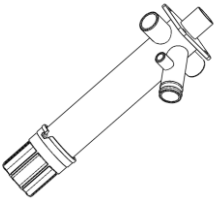
PL	<b>SYFON</b>		
EN	<b>SIPHON</b>		
DE	<b>SIPHON</b>		
RU	<b>СИФОН</b>		
IT	<b>SIFONE</b>		
	<b>SYFON</b>		
<b>18</b>	odnošnik/ reference/ Referenz/ ссылка/ riferimento		
widok/ view/ Ansicht/ вид/ vista	indeks/ index/ Index/ индекс/ codice	szt./ pcs/ Stck./ штук/ Pz.	zastosowanie/ application/ Anwendung/ применение/ funzionalità del ricambio
	<b>Z4350090100</b>	1	EcoCondens SLIM WKD INT EcoCondens SLIM WKD PWM EcoCondens SLIM WKJ INT EcoCondens SLIM WKJ PWM  Na rysunku/ In the picture/ Auf dem Bild/ На рисунке/ In figura: <b>R1, R2, R3, R4</b>



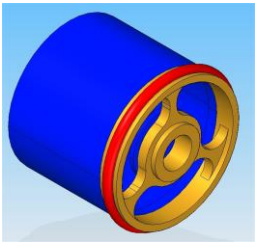

PL	<b>SILNIK ZAWORU TRÓJDROŻNEGO</b>		
EN	<b>3-WAY VALVE MOTOR</b>		
DE	<b>3-WEGE-VENTILMOTOR</b>		
RU	<b>ДВИГАТЕЛЬ ТРЕХХОДОВОГО КЛАПАНА</b>		
IT	<b>MOTORE PER VALVOLA A 3 VIE</b>		
	<b>SILNIK ZAWORU TRÓJ- DROŻNEGO</b>		
<b>21</b>	odnośnik/ reference/ Referenz/ ссылка/ riferimento		
widok/ view/ Ansicht/ вид/ vista	indeks/ index/ Index/ индекс/ codice	szt./ pcs/ Stck./ штук/ Pz.	zastosowanie/ application/ Anwendung/ применение/ funzionalità del ricambio
	<b>Z1480010500</b>	1	EcoCondens SLIM WKD INT EcoCondens SLIM WKD PWM EcoCondens SLIM WKJ INT EcoCondens SLIM WKJ PWM  Na rysunku/ In the picture/ Auf dem Bild/ На рисунке/ In figura: <b>H1, H2, H3, H4</b>

PL	<b>CZUJNIK PRZEPLYWU W.U.</b>		
EN	<b>DOMESTIC WATER FLOW SENSOR</b>		
DE	<b>WASSERDURCHFLUSSENSENSOR</b>		
RU	<b>ДАТЧИК ПРОТОКА ХОЗЯЙСТВЕННОЙ ВОДЫ</b>		
IT	<b>FLUSSOSTATO SANITARIO</b>		
	<b>CZUJNIK PRZEPLYWU W.U.</b>		
<b>23</b>	odnośnik/ reference/ Referenz/ ссылка/ riferimento		
widok/ view/ Ansicht/ вид/ vista	indeks/ index/ Index/ индекс/ codice	szt./ pcs/ Stck./ штук/ Pz.	zastosowanie/ application/ Anwendung/ применение/ funzionalità del ricambio
	<b>Z0700010900</b> typ/ type/ Тип/ тип/ tipo: <b>PA66GF 304</b>	1	EcoCondens SLIM WKD PWM EcoCondens SLIM WKJ PWM  Na rysunku/ In the picture/ Auf dem Bild/ На рисунке/ In figura: <b>H3, H4</b>

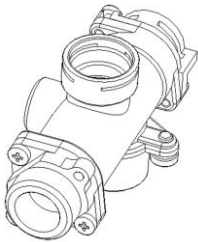
PL	<b>ZAWÓR RÓŻNICOWY Z USZCZELKĄ</b>		
EN	<b>DIFFERENTIAL VALVE WITH GASKET</b>		
DE	<b>DIFFERENZIALVENTIL MIT DICHTUNG</b>		
RU	<b>ДИФФЕРЕНЦИАЛЬНЫЙ КЛАПАН С ПРОКЛАДКОЙ</b>		
IT	<b>VALVOLA DIFFERENZIALE CON GUARNIZIONE</b>		
	ZAWÓR RÓŻNICOWY Z USZCZELKĄ O-RING, OTMA		
<b>24</b>	odnośnik/ reference/ Referenz/ ссылка/ riferimento		
widok/ view/ Ansicht/ вид/ vista	indeks/ index/ Index/ индекс/ codice	szt./ pcs/ Stck./ штук/ Pz.	zastosowanie/ application/ Anwendung/ применение/ funzionalità del ricambio
	<b>Z2450600115</b> typ/ type/ Тип/ тип/ tipo: <b>HDS 15-300</b>	1	EcoCondens SLIM WKD INT EcoCondens SLIM WKD PWM EcoCondens SLIM WKJ INT EcoCondens SLIM WKJ PWM  Na rysunku/ In the picture/ Auf dem Bild/ На рисунке/ In figura: <b>H1, H2, H3, H4</b>

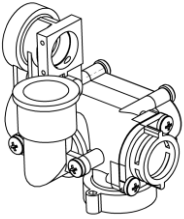
PL	<b>KORPUS ZAWORU TRÓJDROŻNEGO</b>		
EN	<b>3-WAY VALVE BODY</b>		
DE	<b>3-WEGE-VENTILKÖRPER</b>		
RU	<b>КОРПУС ТРЕХХОДОВОГО КЛАПАНА</b>		
IT	<b>CORPO VALVOLA A 3 VIE</b>		
	KORPUS ZAWORU TRÓJDROŻNEGO		
<b>30</b>	odnośnik/ reference/ Referenz/ ссылка/ riferimento		
widok/ view/ Ansicht/ вид/ vista	indeks/ index/ Index/ индекс/ codice	szt./ pcs/ Stck./ штук/ Pz.	zastosowanie/ application/ Anwendung/ применение/ funzionalità del ricambio
	<b>Z1960011100</b> typ/ type/ Тип/ тип/ tipo: <b>500.491</b>  kod/ code/ Code/ код/ codice: <b>30036 6056 06200</b>	1	EcoCondens SLIM WKJ INT EcoCondens SLIM WKJ PWM  Na rysunku/ In the picture/ Auf dem Bild/ На рисунке/ In figura: <b>H1, H2</b>

PL	<b>KORPUS ZAWORU TRÓJDROŻNEGO</b>		
EN	<b>3-WAY VALVE BODY</b>		
DE	<b>3-WEGE-VENTILKÖRPER</b>		
RU	<b>КОРПУС ТРЕХХОДОВОГО КЛАПАНА</b>		
IT	<b>CORPO VALVOLA A 3 VIE</b>		
	KORPUS ZAWORU TRÓJDROŻNEGO		
<b>30a</b>	odnośnik/ reference/ Referenz/ ссылка/ riferimento		
widok/ view/ Ansicht/ вид/ vista	indeks/ index/ Index/ индекс/ codice	szt./ pcs/ Stck./ штук/ Pz.	zastosowanie/ application/ Anwendung/ применение/ funzionalità del ricambio
	<b>Z2450600100</b> typ/ type/ Typ/ тип/ tipo: <b>500.769/D</b> kod/ code/ Code/ код/ codice: <b>30036 6056 10400</b>	1	EcoCondens SLIM WKD INT EcoCondens SLIM WKD PWM  Na rysunku/ In the picture/ Auf dem Bild/ На рисунке/ In figura: <b>H3, H4</b>

PL	<b>PLYTOWY WYMIENNIK CIEPŁA WODA-WODA</b>		
EN	<b>WATER-WATER PLATE HEAT EXCHANGER</b>		
DE	<b>WASSER-WASSER-PLATTENWÄRMETAUSCHER</b>		
RU	<b>ПЛАСТИНЧАТЫЙ ТЕПЛООБМЕННИК</b>		
IT	<b>SCAMBIATORE DI CALORE A PIASTRE ACQUA-ACQUA</b>		
	PLYTOWY WYMIENNIK CIEPŁA - 016		
<b>31</b>	odnośnik/ reference/ Referenz/ ссылка/ riferimento		
widok/ view/ Ansicht/ вид/ vista	indeks/ index/ Index/ индекс/ codice	szt./ pcs/ Stck./ штук/ Pz.	zastosowanie/ application/ Anwendung/ применение/ funzionalità del ricambio
	<b>Z1020012000</b> typ/ type/ Typ/ тип/ tipo: <b>E5P</b> kod/ code/ Code/ код/ codice: <b>18038-016</b>	1	EcoCondens SLIM WKD INT EcoCondens SLIM WKD PWM  Na rysunku/ In the picture/ Auf dem Bild/ На рисунке/ In figura: <b>H3, H4</b>

PL	<b>KORPUS ZAWORÓW</b>			
EN	<b>VALVE BODY</b>			
DE	<b>VENTILKÖRPER</b>			
RU	<b>КОРПУС КЛАПАНОВ</b>			
IT	<b>CORPO VALVOLE</b>			
	<b>KORPUS ZAWORÓW</b>			
<b>32a</b>	odnośnik/ reference/ Referenz/ ссылка/ riferimento			
widok/ view/ Ansicht/ вид/ vista	indeks/ index/ Index/ индекс/ codice	szt./ pcs/ Stck./ штук/ Pz.	zastosowanie/ application/ Anwendung/ применение/ funzionalità del ricambio	
	<b>Z2450600200</b> kod/ code/ Code/ код/ codice: <b>30029605503500</b>	1	EcoCondens SLIM WKD INT EcoCondens SLIM WKD PWM  Na rysunku/ In the picture/ Auf dem Bild/ На рисунке/ In figura: <b>H3, H4</b>	

PL	<b>USZCZELKA</b>			
EN	<b>GASKET</b>			
DE	<b>DICHTUNG</b>			
RU	<b>ПРОКЛАДКА</b>			
IT	<b>GUARNIZIONE</b>			
	<b>USZCZELKA</b>			
<b>37</b>	odnośnik/ reference/ Referenz/ ссылка/ riferimento			
widok/ view/ Ansicht/ вид/ vista	indeks/ index/ Index/ индекс/ codice	szt./ pcs/ Stck./ штук/ Pz.	zastosowanie/ application/ Anwendung/ применение/ funzionalità del ricambio	
	<b>Z2450600014</b>	4	EcoCondens SLIM WKD INT EcoCondens SLIM WKD PWM  Na rysunku/ In the picture/ Auf dem Bild/ На рисунке/ In figura: <b>H3, H4</b>	

PL EN DE RU IT	<b>WEŻYK SILIKONOWY</b> <b>SILICONE TUBE</b> <b>SILIKONSCHLAUCH</b> <b>СИЛИКОНОВЫЙ ТРОСИК</b> <b>TUBETTO IN SILICONE</b>		
WEŻYK SILIKONOWY Ø 6X Ø 9 L=700 MM			
<b>W1</b>	odnośnik/ reference/ Referenz/ ссылка/ riferimento		
widok/ view/ Ansicht/ вид/ vista	indeks/ index/ Index/ индекс/ codice	szt./ pcs/ Stck./ штук/ Pz.	zastosowanie/ application/ Anwendung/ применение/ funzionalità del ricambio
	<b>Z4830000005</b>	1	EcoCondens SLIM WKD INT EcoCondens SLIM WKD PWM EcoCondens SLIM WKJ INT EcoCondens SLIM WKJ PWM  Na rysunku/ In the picture/ Auf dem Bild/ На рисунке/ In figura: <b>R1, R2, R3, R4</b>

PL EN DE RU IT	<b>WEŻYK SILIKONOWY</b> <b>SILICONE TUBE</b> <b>SILIKONSCHLAUCH</b> <b>СИЛИКОНОВЫЙ ТРОСИК</b> <b>TUBETTO IN SILICONE</b>		
WEŻYK SILIKONOWY Ø 4X Ø 7 L=150 MM			
<b>W2</b>	odnośnik/ reference/ Referenz/ ссылка/ riferimento		
widok/ view/ Ansicht/ вид/ vista	indeks/ index/ Index/ индекс/ codice	szt./ pcs/ Stck./ штук/ Pz.	zastosowanie/ application/ Anwendung/ применение/ funzionalità del ricambio
	<b>Z4830000023</b>	1	EcoCondens SLIM WKD INT EcoCondens SLIM WKD PWM EcoCondens SLIM WKJ INT EcoCondens SLIM WKJ PWM  Na rysunku/ In the picture/ Auf dem Bild/ На рисунке/ In figura: <b>R1, R2, R3, R4</b>

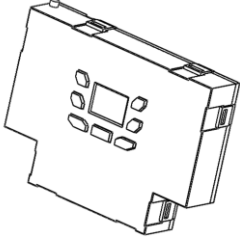
PL	<b>PANEL STEROWANIA</b>		
EN	<b>CONTROL PANEL</b>		
DE	<b>STEUERTAFEL</b>		
RU	<b>ПАНЕЛЬ УПРАВЛЕНИЯ</b>		
IT	<b>PANNELLO DI CONTROLLO</b>		
	PANEL STEROWANIA NEXSYS 2F PWM		
<b>2F PWM</b>	odnošnik/ reference/ Referenz/ ссылка/ riferimento		
widok/ view/ Ansicht/ вид/ vista	indeks/ index/ Index/ индекс/ codice	szt./ pcs/ Stck./ штук/ Pz.	zastosowanie/ application/ Anwendung/ применение/ funzionalità del ricambio
	<b>Z4830200000</b>	1	EcoCondens SLIM WKD PWM  Na rysunku/ In the picture/ Auf dem Bild/ На рисунке/ In figura: <b>R3</b>

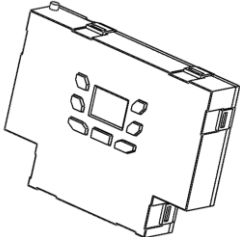
PL	<b>PANEL STEROWANIA</b>		
EN	<b>CONTROL PANEL</b>		
DE	<b>STEUERTAFEL</b>		
RU	<b>ПАНЕЛЬ УПРАВЛЕНИЯ</b>		
IT	<b>PANNELLO DI CONTROLLO</b>		
	PANEL STEROWANIA NEXSYS 2F INT		
<b>2F INT</b>	odnošnik/ reference/ Referenz/ ссылка/ riferimento		
widok/ view/ Ansicht/ вид/ vista	indeks/ index/ Index/ индекс/ codice	szt./ pcs/ Stck./ штук/ Pz.	zastosowanie/ application/ Anwendung/ применение/ funzionalità del ricambio
	<b>Z4890200000</b>	1	EcoCondens SLIM WKD INT  Na rysunku/ In the picture/ Auf dem Bild/ На рисунке/ In figura: <b>R4</b>

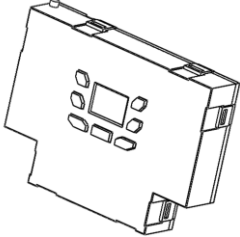
PL	<b>PANEL STEROWANIA</b>		
EN	<b>CONTROL PANEL</b>		
DE	<b>STEUERTAFEL</b>		
RU	<b>ПАНЕЛЬ УПРАВЛЕНИЯ</b>		
IT	<b>PANNELLO DI CONTROLLO</b>		
	PANEL STEROWANIA NEXSYS 1F PWM		
<b>1F PWM</b>	odnošnik/ reference/ Referenz/ ссылка/ riferimento		
widok/ view/ Ansicht/ вид/ vista	indeks/ index/ Index/ индекс/ codice	szt./ pcs/ Stck./ штук/ Pz.	zastosowanie/ application/ Anwendung/ применение/ funzionalità del ricambio
	<b>Z4840200000</b>	1	EcoCondens SLIM WKJ PWM  Na rysunku/ In the picture/ Auf dem Bild/ На рисунке/ In figura: <b>R1</b>

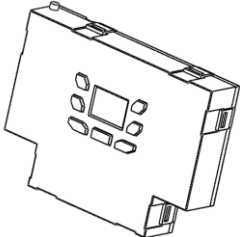
PL	<b>PANEL STEROWANIA</b>		
EN	<b>CONTROL PANEL</b>		
DE	<b>STEUERTAFEL</b>		
RU	<b>ПАНЕЛЬ УПРАВЛЕНИЯ</b>		
IT	<b>PANNELLO DI CONTROLLO</b>		
	PANEL STEROWANIA NEXSYS 1F INT		
<b>1F INT</b>	odnošnik/ reference/ Referenz/ ссылка/ riferimento		
widok/ view/ Ansicht/ вид/ vista	indeks/ index/ Index/ индекс/ codice	szt./ pcs/ Stck./ штук/ Pz.	zastosowanie/ application/ Anwendung/ применение/ funzionalità del ricambio
	<b>Z4900200000</b>	1	EcoCondens SLIM WKJ INT  Na rysunku/ In the picture/ Auf dem Bild/ На рисунке/ In figura: <b>R2</b>

PANEL STEROWANIA/CONTROL PANEL/STEUERER/ПАНЕЛЬ УПРАВЛЕНИЯ

rysunek/ drawing/ Zeichnung/ рисунок/ figura

P

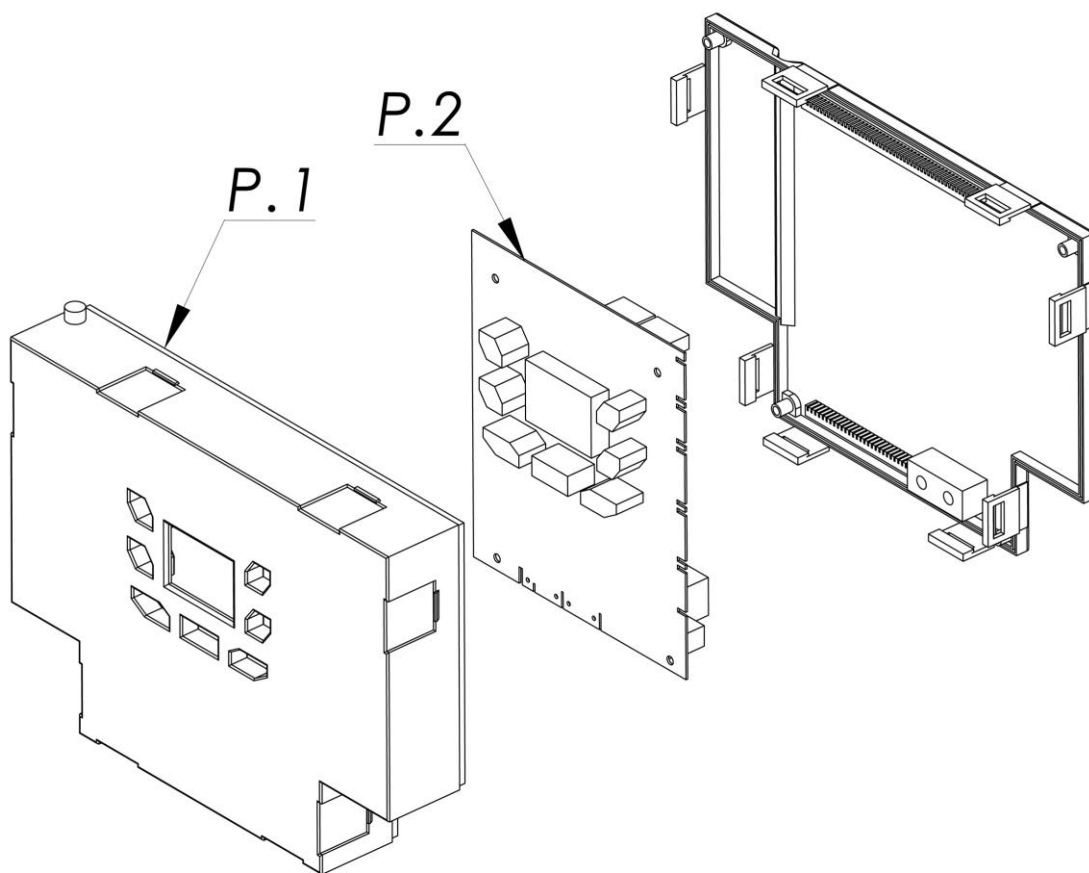

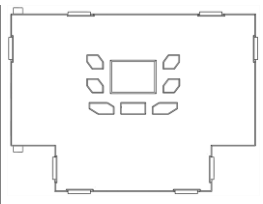

PL	<b>OBUDOWA STEROWNIKA</b>		
EN	<b>CONTROL BOARD HOUSING</b>		
DE	<b>STEUERPLATINENGEHÄUSE</b>		
RU	<b>КОПУС КОМАНДОКОНТРОЛЛЕРА</b>		
IT	<b>COPERCHIO DI PROTEZIONE DEL CONTROLLO ELETTRONICO</b>		
	OBUDOWA STEROWNIKA		
<b>P.1</b>	odnošnik/ reference/ Referenz/ ссылка/ riferimento		
widok/ view/ Ansicht/ вид/ vista	indeks/ index/ Index/ индекс/ codice	szt./ pcs/ Stck./ штук/ Pz.	zastosowanie/ application/ Anwendung/ применение/ funzionalità del ricambio
	<b>Z4830201000</b>	1	EcoCondens SLIM WKD INT EcoCondens SLIM WKD PWM EcoCondens SLIM WKJ INT EcoCondens SLIM WKJ PWM  Na rysunku/ In the picture/ Auf dem Bild/ На рисунке/ In figura: <b>P</b>

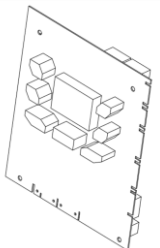
PL	<b>PLYTA STEROWNIKA</b>		
EN	<b>ELECTRONIC BOARD</b>		
DE	<b>ELEKTRONISCHE PLATINE</b>		
RU	<b>ПЛАТА УПРАВЛЕНИЯ</b>		
IT	<b>SCHEDA ELETTRONICA</b>		
	PŁYTA STEROWNIKA NEXSYS		
<b>P.2</b>	odnošnik/ reference/ Referenz/ ссылка/ riferimento		
widok/ view/ Ansicht/ вид/ vista	indeks/ index/ Index/ индекс/ codice	szt./ pcs/ Stck./ штук/ Pz.	zastosowanie/ application/ Anwendung/ применение/ funzionalità del ricambio
	<b>Z4830200100</b> kod/ code/ Code/ код/ codice: <b>S4962V3380</b>	1	EcoCondens SLIM WKD INT EcoCondens SLIM WKD PWM EcoCondens SLIM WKJ INT EcoCondens SLIM WKJ PWM  Na rysunku/ In the picture/ Auf dem Bild/ На рисунке/ In figura: <b>P</b>

**PANEL STEROWANIA NEXSYS PWM 1F, 2F/CONTROL PANEL NEXSYS PWM 1F, 2F/STEUERER NEXSYS PWM 1F, 2F/ПАНЕЛЬ УПРАВЛЕНИЯ NEXSYS PWM 1F, 2F**

rysunek/ drawing/ Zeichnung/ рисунок/ figura

**PWM 1F,  
2F**

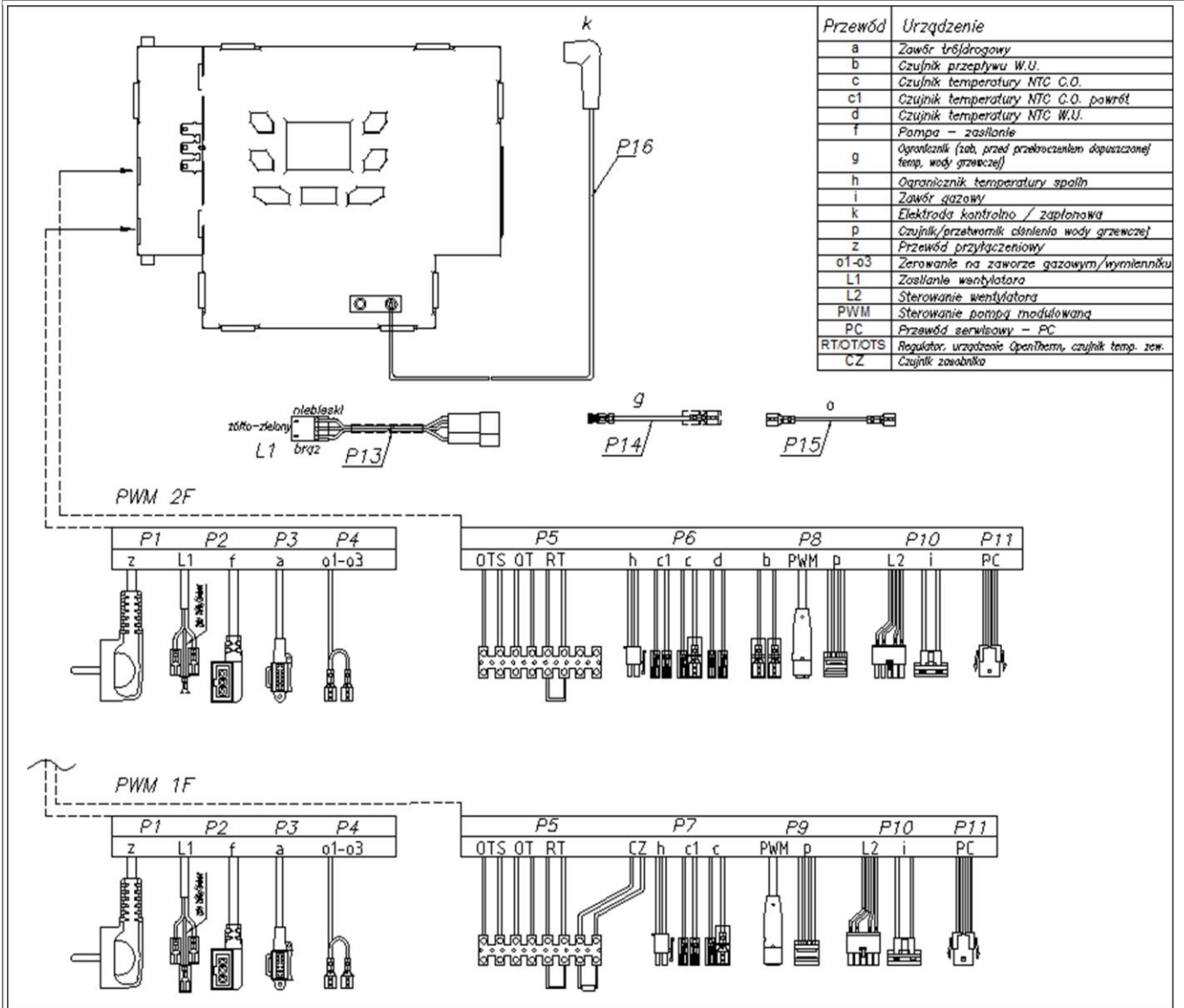

**PANEL STEROWANIA NEXSYS INT 1F, 2F/CONTROL PANEL NEXSYS INT 1F, 2F/STEUERER NEXSYS INT 1F, 2F/ПАНЕЛЬ УПРАВЛЕНИЯ NEXSYS INT 1F, 2F**

rysunek/ drawing/ Zeichnung/ рисунок/ figura

**INT 1F,  
2F**

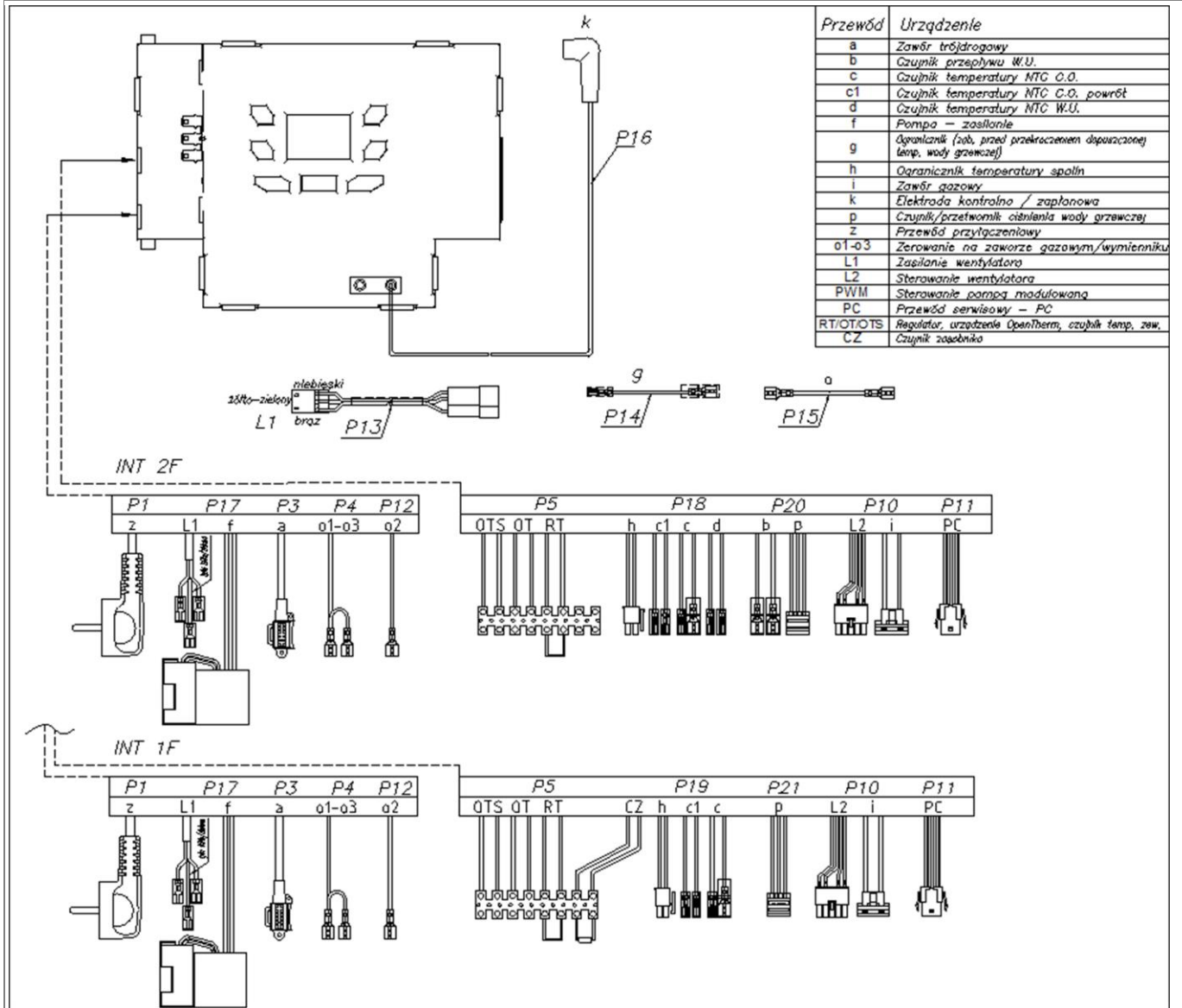

PL	<b>ZESPÓŁ PRZEWODU PRZYŁĄCZENIOWEGO</b>		
EN	<b>CONNECTION CABLE KIT</b>		
DE	<b>ANSCHLUSSKABELSATZ</b>		
RU	<b>УЗЕЛ ПРИСОЕДИНИТЕЛЬНОГО ПРОВОДА</b>		
IT	<b>KIT CAVO DI COLLEGAMENTO</b>		
	PRZEWÓD X12		
<b>P1</b>	odnošnik/ reference/ Referenz/ ссылка/ riferimento		
widok/ view/ Ansicht/ вид/ vista	indeks/ index/ Index/ индекс/ codice	szt./ pcs/ Stck./ штук/ Pz.	zastosowanie/ application/ Anwendung/ применение/ funzionalità del ricambio
	<b>Z4830202100</b>	1	EcoCondens SLIM WKD INT EcoCondens SLIM WKD PWM EcoCondens SLIM WKJ INT EcoCondens SLIM WKJ PWM  Na rysunku/ In the picture/ Auf dem Bild/ На рисунке/ In figura: <b>PWM 1F, 2F; INT 1F, 2F</b>

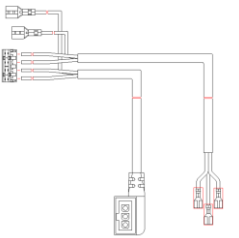
PL	<b>ZESPÓŁ PRZEWODU POMPY I WENTYLATORA</b>		
EN	<b>CABLE HARNESS OF PUMP AND FAN</b>		
DE	<b>KABELBAUM VON PUMPE UND LÜFTER</b>		
RU	<b>УЗЕЛ ПРОВОДА НАСОСА И ВЕНТИЛЯТОРА</b>		
IT	<b>KIT CAVI DEL CIRCOLATORE E DEL VENTILATORE</b>		
	WIAŹKA X11		
<b>P2</b>	odnošnik/ reference/ Referenz/ ссылка/ riferimento		
widok/ view/ Ansicht/ вид/ vista	indeks/ index/ Index/ индекс/ codice	szt./ pcs/ Stck./ штук/ Pz.	zastosowanie/ application/ Anwendung/ применение/ funzionalità del ricambio
	<b>Z4830203100</b>	1	EcoCondens SLIM WKD PWM EcoCondens SLIM WKJ PWM  Na rysunku/ In the picture/ Auf dem Bild/ На рисунке/ In figura: <b>PWM 1F, 2F</b>

PL	<b>PRZEWÓD ZAWORU TRÓJDROŻNEGO</b>		
EN	<b>3-WAY VALVE CABLE</b>		
DE	<b>3-WEGE-VENTILKABEL</b>		
RU	<b>ПРОВОД ТРЕХХОДОВОГО КЛАПАНА</b>		
IT	<b>CAVO DELLA VALVOLA A 3 VIE</b>		
	PRZEWÓD X10		
<b>P3a</b>	odnošnik/ reference/ Referenz/ ссылка/ riferimento		
widok/ view/ Ansicht/ вид/ vista	indeks/ index/ Index/ индекс/ codice	szt./ pcs/ Stck./ штук/ Pz.	zastosowanie/ application/ Anwendung/ применение/ funzionalità del ricambio
	<b>Z4830202300</b>	1	EcoCondens SLIM WKD INT EcoCondens SLIM WKD PWM  Na rysunku/ In the picture/ Auf dem Bild/ На рисунке/ In figura: <b>PWM 2F; INT 2F</b>

PL	<b>PRZEWÓD ZAWORU TRÓJDROŻNEGO</b>		
EN	<b>3-WAY VALVE CABLE</b>		
DE	<b>3-WEGE-VENTILKABEL</b>		
RU	<b>ПРОВОД ТРЕХХОДОВОГО КЛАПАНА</b>		
IT	<b>CAVO DELLA VALVOLA A 3 VIE</b>		
	PRZEWÓD X10		
<b>P3b</b>	odnošnik/ reference/ Referenz/ ссылка/ riferimento		
widok/ view/ Ansicht/ вид/ vista	indeks/ index/ Index/ индекс/ codice	szt./ pcs/ Stck./ штук/ Pz.	zastosowanie/ application/ Anwendung/ применение/ funzionalità del ricambio
	<b>Z4840202300</b>	1	EcoCondens SLIM WKJ INT EcoCondens SLIM WKJ PWM  Na rysunku/ In the picture/ Auf dem Bild/ На рисунке/ In figura: <b>PWM 1F; INT 1F</b>

PL	<b>PRZEWÓD ZERUJĄCY</b>		
EN	<b>NEUTRAL CABLE</b>		
DE	<b>NEUTRALLEITER</b>		
RU	<b>ПРОВОД ЗАНУЛЯЮЩИЙ</b>		
IT	<b>CAVO NEUTRO</b>		
	PRZEWÓD ZERUJĄCY O1-O3		
<b>P4</b>	odnošnik/ reference/ Referenz/ ссылка/ riferimento		
widok/ view/ Ansicht/ вид/ vista	indeks/ index/ Index/ индекс/ codice	szt./ pcs/ Stck./ штук/ Pz.	zastosowanie/ application/ Anwendung/ применение/ funzionalità del ricambio
	<b>Z4830203000</b>	1	EcoCondens SLIM WKD INT EcoCondens SLIM WKD PWM EcoCondens SLIM WKJ INT EcoCondens SLIM WKJ PWM  Na rysunku/ In the picture/ Auf dem Bild/ На рисунке/ In figura: <b>PWM 1F, 2F; INT 1F, 2F</b>

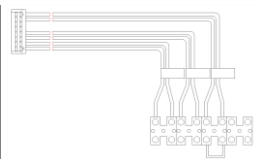
PL	<b>PRZYŁĄCZE RT,OT I OTS</b>		
EN	<b>RT, OT AND OTS TERMINALS</b>		
DE	<b>RT-, OT- UND OTS-TERMINALS</b>		
RU	<b>ПРИСОЕДИНЕНИЕ ТЕРМОСТАЁТОВ RT,OT I OTS - ПУЧОК ПРОВОДОВ X3</b>		
IT	<b>KIT CONNESSIONE RT, OT E OTS</b>		
	WIAZKA X3		
<b>P5</b>	odnošnik/ reference/ Referenz/ ссылка/ riferimento		
widok/ view/ Ansicht/ вид/ vista	indeks/ index/ Index/ индекс/ codice	szt./ pcs/ Stck./ штук/ Pz.	zastosowanie/ application/ Anwendung/ применение/ funzionalità del ricambio
	<b>Z4830202400</b>	1	EcoCondens SLIM WKD INT EcoCondens SLIM WKD PWM EcoCondens SLIM WKJ INT EcoCondens SLIM WKJ PWM  Na rysunku/ In the picture/ Auf dem Bild/ На рисунке/ In figura: <b>PWM 1F, 2F; INT 1F, 2F</b>

PL	<b>ZESPÓŁ PRZEWODU CZUJNIKÓW</b>		
EN	<b>SENSOR CABLE HARNESS</b>		
DE	<b>SENSOR-KABELBAUM</b>		
RU	<b>УЗЕЛ ПРОВОДА ДАТЧИКОВ</b>		
IT	<b>FASCIO DI CAVI DEI SENSORI</b>		
	WIAZKA X5		
<b>P6</b>	odnošnik/ reference/ Referenz/ ссылка/ riferimento		
widok/ view/ Ansicht/ вид/ vista	indeks/ index/ Index/ индекс/ codice	szt./ pcs/ Stck./ штук/ Pz.	zastosowanie/ application/ Anwendung/ применение/ funzionalità del ricambio
	<b>Z4830202500</b>	1	EcoCondens SLIM WKD PWM  Na rysunku/ In the picture/ Auf dem Bild/ На рисунке/ In figura: <b>PWM 1F, 2F</b>

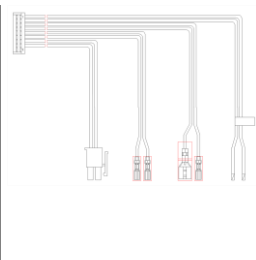
PL	<b>ZESPÓŁ PRZEWODU CZUJNIKÓW</b>		
EN	<b>SENSOR CABLE HARNESS</b>		
DE	<b>SENSOR-KABELBAUM</b>		
RU	<b>УЗЕЛ ПРОВОДА ДАТЧИКОВ</b>		
IT	<b>FASCIO DI CAVI DEI SENSORI</b>		
	WIĄZKA X5 (JEDNOFUNKCYJNE)		
<b>P7</b>	odnośnik/ reference/ Referenz/ ссылка/ riferimento		
widok/ view/ Ansicht/ вид/ vista	indeks/ index/ Index/ индекс/ codice	szt./ pcs/ Stck./ штук/ Pz.	zastosowanie/ application/ Anwendung/ применение/ funzionalità del ricambio
	<b>Z4840202500</b>	1	EcoCondens SLIM WKJ PWM  Na rysunku/ In the picture/ Auf dem Bild/ На рисунке/ In figura: <b>PWM 1F, 2F</b>

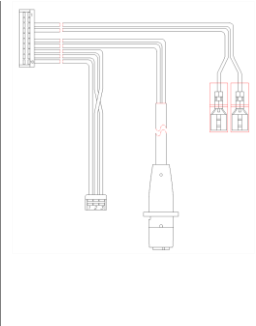
PL	<b>ZESPÓŁ PRZEWODU CZUJNIKÓW I PWM</b>		
EN	<b>CABLE HARNESS OF PWM PUMP AND SENSORS</b>		
DE	<b>KABELBAUM DER PWM-PUMPE UND DER SENSOREN</b>		
RU	<b>УЗЕЛ ПРОВОДА ДАТЧИКОВ И НАСОСА PWN</b>		
IT	<b>FASCIO DI CAVI DEI SENSORI E DEL CIRCOLATORE PWM</b>		
	WIĄZKA X7		
<b>P8</b>	odnośnik/ reference/ Referenz/ ссылка/ riferimento		
widok/ view/ Ansicht/ вид/ vista	indeks/ index/ Index/ индекс/ codice	szt./ pcs/ Stck./ штук/ Pz.	zastosowanie/ application/ Anwendung/ применение/ funzionalità del ricambio
	<b>Z4830202600</b>	1	EcoCondens SLIM WKD PWM  Na rysunku/ In the picture/ Auf dem Bild/ На рисунке/ In figura: <b>PWM 1F, 2F</b>

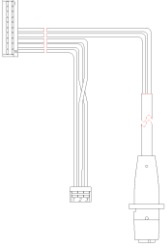
PL	<b>ZESPÓŁ PRZEWODU CZUJNIKÓW I PWM</b>		
EN	<b>CABLE HARNESS OF PWM PUMP AND SENSORS</b>		
DE	<b>KABELBAUM DER PWM-PUMPE UND DER SENSOREN</b>		
RU	<b>УЗЕЛ ПРОВОДА ДАТЧИКОВ И НАСОСА PWN</b>		
IT	<b>FASCIO DI CAVI DEI SENSORI E DEL CIRCOLATORE PWM</b>		
	WIAZKA X7 (JEDNOFUNKCYJNE)		
<b>P9</b>	odnośnik/ reference/ Referenz/ ссылка/ riferimento		
widok/ view/ Ansicht/ вид/ vista	indeks/ index/ Index/ индекс/ codice	szt./ pcs/ Stck./ штук/ Pz.	zastosowanie/ application/ Anwendung/ применение/ funzionalità del ricambio
	<b>Z4840202600</b>	1	EcoCondens SLIM WKJ PWM  Na rysunku/ In the picture/ Auf dem Bild/ На рисунке/ In figura: <b>PWM 1F, 2F</b>

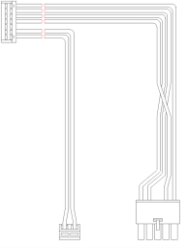
PL	<b>ZESPÓŁ PRZEWODU ZAWORU GAZOWEGO I WENTYLATORA</b>		
EN	<b>CABLE HARNESS OF FAN AND GAS VALVE</b>		
DE	<b>KABELBAUM VON LÜFTER UND GASVENTIL</b>		
RU	<b>УЗЕЛ ПРОВОДА ГАЗОВОГО КЛАПАНА И ВЕНТИЛЯТОРА</b>		
IT	<b>KIT CAVO DELLA VALVOLA DEL GAS E DEL VENTILATORE</b>		
	WIAZKA X4		
<b>P10</b>	odnośnik/ reference/ Referenz/ ссылка/ riferimento		
widok/ view/ Ansicht/ вид/ vista	indeks/ index/ Index/ индекс/ codice	szt./ pcs/ Stck./ штук/ Pz.	zastosowanie/ application/ Anwendung/ применение/ funzionalità del ricambio
	<b>Z4830202700</b>	1	EcoCondens SLIM WKD INT EcoCondens SLIM WKD PWM EcoCondens SLIM WKJ INT EcoCondens SLIM WKJ PWM  Na rysunku/ In the picture/ Auf dem Bild/ На рисунке/ In figura: <b>PWM 1F, 2F; INT 1F, 2F</b>





PL EN DE RU IT	<b>PRZEWÓD SERWISOWY</b> <b>SERVICE CABLE</b> <b>SERVICEKABEL</b> <b>СЕРВИСНЫЙ КАБЕЛЬ</b> <b>CAVO DI SERVIZIO</b>		
	PRZEWÓD SERWISOWY PC		
<b>P11</b>	odnošnik/ reference/ Referenz/ ссылка/ riferimento		
widok/ view/ Ansicht/ вид/ vista	indeks/ index/ Index/ индекс/ codice	szt./ pcs/ Stck./ штук/ Pz.	zastosowanie/ application/ Anwendung/ применение/ funzionalità del ricambio
	<b>Z4830202800</b>	1	EcoCondens SLIM WKD INT EcoCondens SLIM WKD PWM EcoCondens SLIM WKJ INT EcoCondens SLIM WKJ PWM  Na rysunku/ In the picture/ Auf dem Bild/ На рисунке/ In figura: <b>PWM 1F, 2F; INT 1F, 2F</b>

PL EN DE RU IT	<b>PRZEWÓD ZERUJĄCY</b> <b>NEUTRAL CABLE</b> <b>NEUTRALLEITER</b> <b>ПРОВОД ЗАНУЛЯЮЩИЙ</b> <b>CAVO NEUTRO</b>		
	PRZEWÓD ZERUJĄCY O2		
<b>P12</b>	odnošnik/ reference/ Referenz/ ссылка/ riferimento		
widok/ view/ Ansicht/ вид/ vista	indeks/ index/ Index/ индекс/ codice	szt./ pcs/ Stck./ штук/ Pz.	zastosowanie/ application/ Anwendung/ применение/ funzionalità del ricambio
	<b>Z4890203000</b>	1	EcoCondens SLIM WKD INT EcoCondens SLIM WKJ INT  Na rysunku/ In the picture/ Auf dem Bild/ На рисунке/ In figura: <b>INT 1F, 2F</b>

PL	<b>PRZEDŁUŻKA ZASILANIA WENTYLATORA</b>		
EN	<b>FAN POWER EXTENSION CABLE</b>		
DE	<b>VERLÄNGERUNGSKABEL FÜR LÜFTERLEISTUNG</b>		
RU	<b>УДЛИНИТЕЛЬ ПРОВОДА ПИТАНИЯ ВЕНТЛЯТОРА</b>		
IT	<b>CAVO DI ESTENSIONE ALIMENTAZIONE DEL VENTILATORE</b>		
	PRZEDŁUŻKA ZASILANIA WENTYLATORA		
<b>P13</b>	odnośnik/ reference/ Referenz/ ссылка/ riferimento		
widok/ view/ Ansicht/ вид/ vista	indeks/ index/ Index/ индекс/ codice	szt./ pcs/ Stck./ штук/ Pz.	zastosowanie/ application/ Anwendung/ применение/ funzionalità del ricambio
	<b>Z2650004000</b>	1	EcoCondens SLIM WKD INT EcoCondens SLIM WKD PWM EcoCondens SLIM WKJ INT EcoCondens SLIM WKJ PWM  Na rysunku/ In the picture/ Auf dem Bild/ На рисунке/ In figura: <b>PWM 1F, 2F; INT 1F, 2F</b>

PL	<b>PRZEWÓD OGRANICZNIKÓW</b>		
EN	<b>LIMITERS CABLE</b>		
DE	<b>KABEL DES BEGRENZERS</b>		
RU	<b>ПРОВОД ОГРАНИЧИТЕЛЕЙ</b>		
IT	<b>CAVO DEI LIMITATORI</b>		
	PRZEWÓD OGRANICZNIKA		
<b>P14</b>	odnośnik/ reference/ Referenz/ ссылка/ riferimento		
widok/ view/ Ansicht/ вид/ vista	indeks/ index/ Index/ индекс/ codice	szt./ pcs/ Stck./ штук/ Pz.	zastosowanie/ application/ Anwendung/ применение/ funzionalità del ricambio
	<b>Z4830004100</b>	1	EcoCondens SLIM WKD INT EcoCondens SLIM WKD PWM EcoCondens SLIM WKJ INT EcoCondens SLIM WKJ PWM  Na rysunku/ In the picture/ Auf dem Bild/ На рисунке/ In figura: <b>PWM 1F, 2F; INT 1F, 2F</b>

PL	<b>PRZEWÓD UZIEMIAJĄCY</b>		
EN	<b>GROUNDING CABLE</b>		
DE	<b>ERDUNGSKABEL</b>		
RU	<b>ПРОВОД ЗАЗЕМЛЕНИЯ</b>		
IT	<b>CAVO DI MESSA A TERRA</b>		
	PRZEWÓZ UZIEMNIAJĄCY		
<b>P15</b>	odnošnik/ reference/ Referenz/ ссылка/ riferimento		
widok/ view/ Ansicht/ вид/ vista	indeks/ index/ Index/ индекс/ codice	szt./ pcs/ Stck./ штук/ Pz.	zastosowanie/ application/ Anwendung/ применение/ funzionalità del ricambio
	<b>Z4830202900</b>	1	EcoCondens SLIM WKD INT EcoCondens SLIM WKD PWM EcoCondens SLIM WKJ INT EcoCondens SLIM WKJ PWM  Na rysunku/ In the picture/ Auf dem Bild/ На рисунке/ In figura: <b>PWM 1F, 2F; INT 1F, 2F</b>

PL	<b>PRZEWÓD ZAPALACZA</b>		
EN	<b>IGNITION CABLE</b>		
DE	<b>ZÜNDKABEL</b>		
RU	<b>ПРОВОД ЗАЖИГАТЕЛЯ</b>		
IT	<b>CAVETTO ACCENSIONE</b>		
	PODZ. PRZEWODU ZAPALACZA		
<b>P16</b>	odnošnik/ reference/ Referenz/ ссылка/ riferimento		
widok/ view/ Ansicht/ вид/ vista	indeks/ index/ Index/ индекс/ codice	szt./ pcs/ Stck./ штук/ Pz.	zastosowanie/ application/ Anwendung/ применение/ funzionalità del ricambio
	<b>Z4990202900</b>  typ/ type/ Тип/ тип/ tipo: <b>XXX</b>	1	EcoCondens SLIM WKD INT EcoCondens SLIM WKD PWM EcoCondens SLIM WKJ INT EcoCondens SLIM WKJ PWM  Na rysunku/ In the picture/ Auf dem Bild/ На рисунке/ In figura: <b>PWM 1F, 2F; INT 1F, 2F</b>

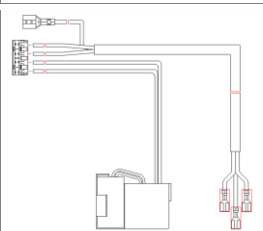
PL	<b>ZESPÓŁ PRZEWODU POMPY I WENTYLATORA</b>		
EN	<b>CABLE HARNESS OF PUMP AND FAN</b>		
DE	<b>KABELBAUM VON PUMPE UND LÜFTER</b>		
RU	<b>УЗЕЛ ПРОВОДА НАСОСА И ВЕНТИЛЯТОРА</b>		
IT	<b>KIT CAVI DEL CIRCOLATORE E DEL VENTILATORE</b>		
	WIAZKA X11		
<b>P17</b>	odnošnik/ reference/ Referenz/ ссылка/ riferimento		
widok/ view/ Ansicht/ вид/ vista	indeks/ index/ Index/ индекс/ codice	szt./ pcs/ Stck./ штук/ Pz.	zastosowanie/ application/ Anwendung/ применение/ funzionalità del ricambio
	<b>Z4890203100</b>	1	EcoCondens SLIM WKD INT EcoCondens SLIM WKJ INT  Na rysunku/ In the picture/ Auf dem Bild/ На рисунке/ In figura: <b>INT 1F, 2F</b>

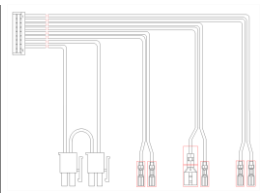
PL	<b>ZESPÓŁ PRZEWODU CZUJNIKÓW</b>		
EN	<b>SENSOR CABLE HARNESS</b>		
DE	<b>SENSOR-KABELBAUM</b>		
RU	<b>УЗЕЛ ПРОВОДА ДАТЧИКОВ</b>		
IT	<b>FASCIO DI CAVI DEI SENSORI</b>		
	WIAZKA X5		
<b>P18</b>	odnošnik/ reference/ Referenz/ ссылка/ riferimento		
widok/ view/ Ansicht/ вид/ vista	indeks/ index/ Index/ индекс/ codice	szt./ pcs/ Stck./ штук/ Pz.	zastosowanie/ application/ Anwendung/ применение/ funzionalità del ricambio
	<b>Z4990202500</b>	1	EcoCondens SLIM WKD INT  Na rysunku/ In the picture/ Auf dem Bild/ На рисунке/ In figura: <b>INT 2F</b>

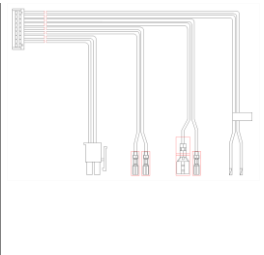
PL	<b>ZESPÓŁ PRZEWODU CZUJNIKÓW</b>		
EN	<b>SENSOR CABLE HARNESS</b>		
DE	<b>SENSOR-KABELBAUM</b>		
RU	<b>УЗЕЛ ПРОВОДА ДАТЧИКОВ</b>		
IT	<b>FASCIO DI CAVI DEI SENSORI</b>		
	WIĄZKA X5		
<b>P19</b>	odnośnik/ reference/ Referenz/ ссылка/ riferimento		
widok/ view/ Ansicht/ вид/ vista	indeks/ index/ Index/ индекс/ codice	szt./ pcs/ Stck./ штук/ Pz.	zastosowanie/ application/ Anwendung/ применение/ funzionalità del ricambio
	<b>Z4900202500</b>	1	EcoCondens SLIM WKJ INT  Na rysunku/ In the picture/ Auf dem Bild/ На рисунке/ In figura: <b>INT 1F</b>

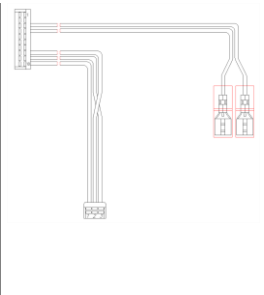
PL	<b>ZESPÓŁ PRZEWODU CZUJNIKÓW</b>		
EN	<b>SENSOR CABLE HARNESS</b>		
DE	<b>SENSOR-KABELBAUM</b>		
RU	<b>УЗЕЛ ПРОВОДА ДАТЧИКОВ</b>		
IT	<b>FASCIO DI CAVI DEI SENSORI</b>		
	WIĄZKA X7		
<b>P20</b>	odnośnik/ reference/ Referenz/ ссылка/ riferimento		
widok/ view/ Ansicht/ вид/ vista	indeks/ index/ Index/ индекс/ codice	szt./ pcs/ Stck./ штук/ Pz.	zastosowanie/ application/ Anwendung/ применение/ funzionalità del ricambio
	<b>Z4890202600</b>	1	EcoCondens SLIM WKD INT  Na rysunku/ In the picture/ Auf dem Bild/ На рисунке/ In figura: <b>INT 2F</b>

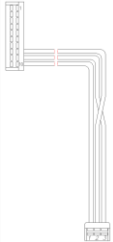
PL	<b>ZESPÓŁ PRZEWODU CZUJNIKÓW</b>		
EN	<b>SENSOR CABLE HARNESS</b>		
DE	<b>SENSOR-KABELBAUM</b>		
RU	<b>УЗЕЛ ПРОВОДА ДАТЧИКОВ</b>		
IT	<b>FASCIO DI CAVI DEI SENSORI</b>		
	PRZEWÓD X7		
<b>P21</b>	odnośnik/ reference/ Referenz/ ссылка/ riferimento		
widok/ view/ Ansicht/ вид/ vista	indeks/ index/ Index/ индекс/ codice	szt./ pcs/ Stck./ штук/ Pz.	zastosowanie/ application/ Anwendung/ применение/ funzionalità del ricambio
	<b>Z4900202600</b>	1	EcoCondens SLIM WKJ INT  Na rysunku/ In the picture/ Auf dem Bild/ На рисунке/ In figura: <b>INT 1F</b>

**WYMIENNIK CIEPŁA SPALINY - WODA/FLUE GAS – WATER EXCHANGER/ABGAS-WASSER  
WÄRMETAUSCHER/ТЕПЛООБМЕННИК ПРОДУКТЫ СГОРАНИЯ-ВОДА**

rysunek/ drawing/ Zeichnung/ рисунок/ figura

2

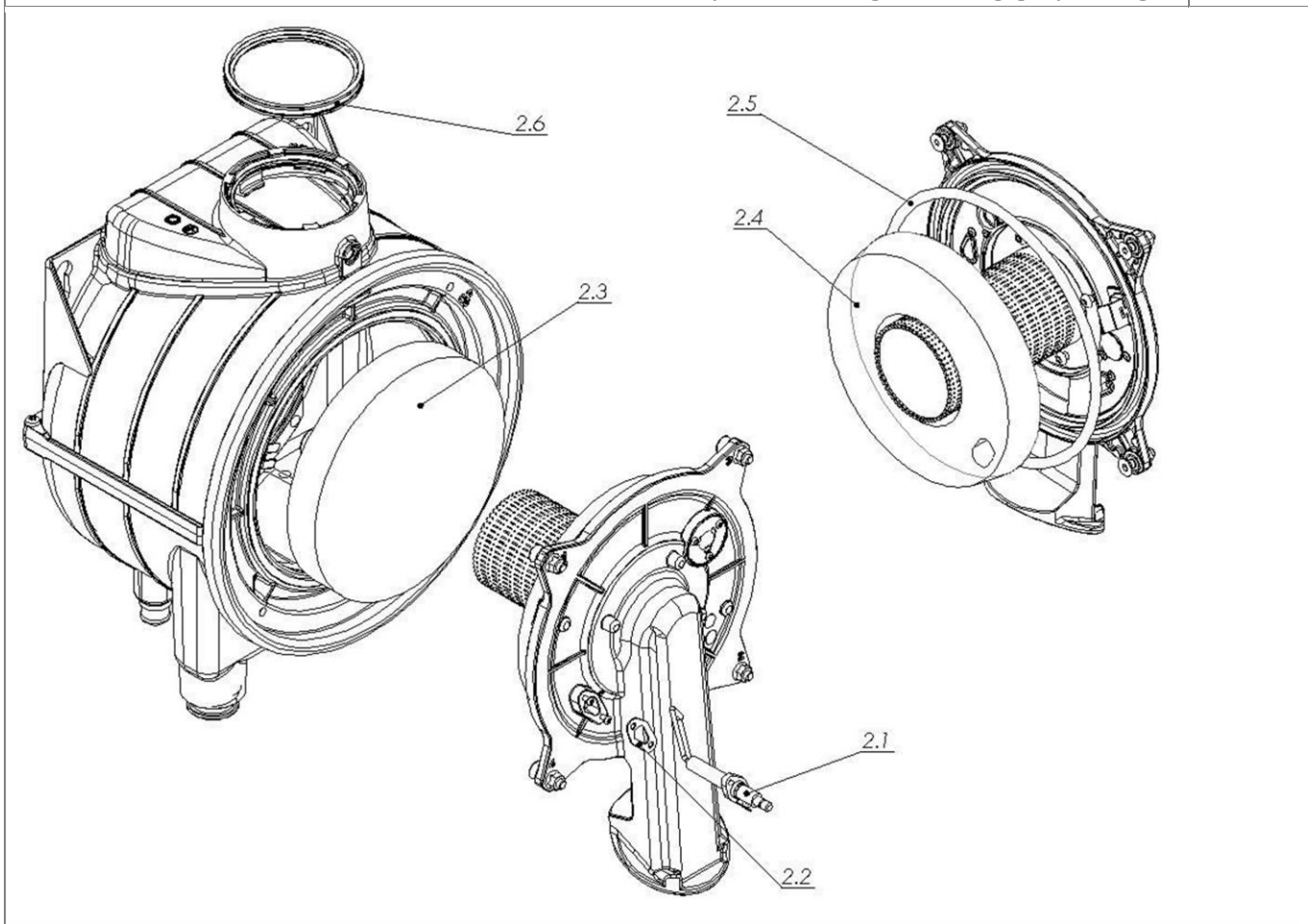

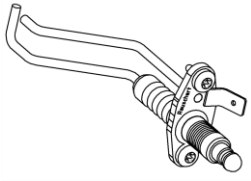
PL	<b>ELEKTRODA ZAPŁONOWA / KONTROLI PŁOMIENIA</b>		
EN	<b>IGNITION/FLAME CONTROL ELECTRODE</b>		
DE	<b>ZÜND-/FLAMMKONTROLLELEKTRODE</b>		
RU	<b>ЭЛЕКТРОД ЗАЖИГАЮЩИЙ/КОНТРОЛЯ ПЛАМЕНИ</b>		
IT	<b>ELETTRODO ACCENSIONE/RILEVAZIONE</b>		
	ELEKTRODA ZAPŁONOWA / KONTROLI PŁOMIENIA		
<b>2.1</b>	odnośnik/ reference/ Referenz/ ссылка/ riferimento		
widok/ view/ Ansicht/ вид/ vista	indeks/ index/ Index/ индекс/ codice	szt./ pcs/ Stck./ штук/ Pz.	zastosowanie/ application/ Anwendung/ применение/ funzionalità del ricambio
	<b>Z4350040400</b> kod/ code/ Code/ код/ codice: <b>MPCEUK1C01</b>	1	EcoCondens SLIM WKD INT EcoCondens SLIM WKD PWM EcoCondens SLIM WKJ INT EcoCondens SLIM WKJ PWM  Na rysunku/ In the picture/ Auf dem Bild/ На рисунке/ In figura: <b>2</b>

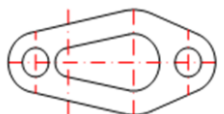
PL	<b>USZCZELKA ELEKTRODY</b>		
EN	<b>ELECTRODE GASKET</b>		
DE	<b>ELEKTRODENDICHTUNG</b>		
RU	<b>ПРОКЛАДКА ЭЛЕКТРОДА</b>		
IT	<b>GUARNIZIONE ELETTRODO</b>		
	USZCZELKA ELEKTRODY		
<b>2.2</b>	odnośnik/ reference/ Referenz/ ссылка/ riferimento		
widok/ view/ Ansicht/ вид/ vista	indeks/ index/ Index/ индекс/ codice	szt./ pcs/ Stck./ штук/ Pz.	zastosowanie/ application/ Anwendung/ применение/ funzionalità del ricambio
	<b>Z4350040202</b> kod/ code/ Code/ код/ codice: <b>MPMG118</b>	1	EcoCondens SLIM WKD INT EcoCondens SLIM WKD PWM EcoCondens SLIM WKJ INT EcoCondens SLIM WKJ PWM  Na rysunku/ In the picture/ Auf dem Bild/ На рисунке/ In figura: <b>2</b>

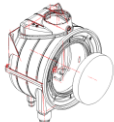
PL	<b>IZOLACJA TERMICZNA WEWNĘTRZNA</b>		
EN	<b>INTERNAL THERMAL INSULATION</b>		
DE	<b>INTERNE THERMISCHE ISOLIERUNG</b>		
RU	<b>ТЕРМИЧЕСКАЯ ИЗОЛЯЦИЯ ВНУТРЕННЯЯ</b>		
IT	<b>ISOLAMENTO TERMICO INTERNO</b>		
	IZOLACJA TERMICZNA WEWNĘTRZNA		
<b>2.3</b>	odnośnik/ reference/ Referenz/ ссылка/ riferimento		
widok/ view/ Ansicht/ вид/ vista	indeks/ index/ Index/ индекс/ codice	szt./ pcs/ Stck./ штук/ Pz.	zastosowanie/ application/ Anwendung/ применение/ funzionalità del ricambio
	<b>Z4390040001</b> kod/ code/ Code/ код/ codice: <b>PFCEKR003</b>	1	EcoCondens SLIM WKD INT EcoCondens SLIM WKD PWM EcoCondens SLIM WKJ INT EcoCondens SLIM WKJ PWM  Na rysunku/ In the picture/ Auf dem Bild/ На рисунке/ In figura: 2

PL	<b>IZOLACJA POKRYWY KOMORY</b>		
EN	<b>BURNER DOOR INSULATION</b>		
DE	<b>ISOLIERUNG DER BRENNERTÜR</b>		
RU	<b>ИЗОЛЯЦИЯ КРЫШЫ КАМЕРЫ</b>		
IT	<b>ISOLAMENTO DELLA PORTA DEL BRUCIATORE</b>		
	IZOLACJA POKRYWY KOMORY		
<b>2.4</b>	odnośnik/ reference/ Referenz/ ссылка/ riferimento		
widok/ view/ Ansicht/ вид/ vista	indeks/ index/ Index/ индекс/ codice	szt./ pcs/ Stck./ штук/ Pz.	zastosowanie/ application/ Anwendung/ применение/ funzionalità del ricambio
	<b>Z4390040201</b> kod/ code/ Code/ код/ codice: <b>MPCESS0003</b>	1	EcoCondens SLIM WKD INT EcoCondens SLIM WKD PWM EcoCondens SLIM WKJ INT EcoCondens SLIM WKJ PWM  Na rysunku/ In the picture/ Auf dem Bild/ На рисунке/ In figura: 2

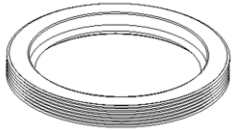

PL	<b>USZCZELKA POKRYWY</b>		
EN	<b>BURNER DOOR GASKET</b>		
DE	<b>DICHTUNG DER BRENNERTÜR</b>		
RU	<b>ПРОКЛАДКА КРЫШЫ</b>		
IT	<b>GUARNIZIONE DELLA PORTA DEL BRUCIATORE</b>		
	USZCZELKA POKRYWY		
<b>2.5</b>	odnośnik/ reference/ Referenz/ ссылка/ riferimento		
widok/ view/ Ansicht/ вид/ vista	indeks/ index/ Index/ индекс/ codice	szt./ pcs/ Stck./ штук/ Pz.	zastosowanie/ application/ Anwendung/ применение/ funzionalità del ricambio
	<b>Z4390040203</b> kod/ code/ Code/ код/ codice: <b>MPMG115</b>	1	EcoCondens SLIM WKD INT EcoCondens SLIM WKD PWM EcoCondens SLIM WKJ INT EcoCondens SLIM WKJ PWM  Na rysunku/ In the picture/ Auf dem Bild/ На рисунке/ In figura: <b>2</b>

PL	<b>USZCZELKA WYLOTU SPALIN</b>		
EN	<b>FLUE OUTLET GASKET</b>		
DE	<b>RAUCHABZUGSDICHTUNG</b>		
RU	<b>ПРОКЛАДКА ВЫХОДА ПРОДУКТОВ СГОРАНИЯ</b>		
IT	<b>GUARNIZIONE USCITA FUMI</b>		
	USZCZELKA WYLOTU SPALIN		
<b>2.6</b>	odnośnik/ reference/ Referenz/ ссылка/ riferimento		
widok/ view/ Ansicht/ вид/ vista	indeks/ index/ Index/ индекс/ codice	szt./ pcs/ Stck./ штук/ Pz.	zastosowanie/ application/ Anwendung/ применение/ funzionalità del ricambio
	<b>Z4350040003</b> kod/ code/ Code/ код/ codice: <b>MPMG105</b> lub/ or/ oder/ или/ o  <b>Z0720040005</b> typ/ type/ Typ/ тип/ tipo: <b>GM-10-25-080</b>	1	EcoCondens SLIM WKD INT EcoCondens SLIM WKD PWM EcoCondens SLIM WKJ INT EcoCondens SLIM WKJ PWM  Na rysunku/ In the picture/ Auf dem Bild/ На рисунке/ In figura: <b>2</b>

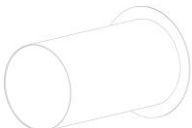
PL EN DE RU IT	<b>PALNIK BURNER BRENNER ГОРЕЛКА BRUCIATORE</b>		
	PALNIK CONDEVO 20 KW		
<b>2.7</b>	odnošnik/ reference/ Referenz/ ссылка/ riferimento		
widok/ view/ Ansicht/ вид/ vista	indeks/ index/ Index/ индекс/ codice	szt./ pcs/ Stck./ штук/ Pz.	zastosowanie/ application/ Anwendung/ применение/ funzionalità del ricambio
	<b>Z4390040300</b> kod/ code/ Code/ код/ codice: <b>MPCEBR002</b>	1	EcoCondens SLIM WKD INT EcoCondens SLIM WKD PWM EcoCondens SLIM WKJ INT EcoCondens SLIM WKJ PWM  Na rysunku/ In the picture/ Auf dem Bild/ На рисунке/ In figura: <b>2</b>

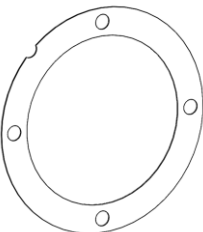
	<b>USZCZELKA PALNIKA</b>		
	odnošnik/ reference/ Referenz/ ссылка/ riferimento		
widok/ view/ Ansicht/ вид/ vista	indeks/ index/ Index/ индекс/ codice	szt./ pcs/ Stck./ штук/ Pz.	zastosowanie/ application/ Anwendung/ применение/ funzionalità del ricambio
	<b>Z4390040101</b> kod/ code/ Code/ код/ codice: <b>MPMG120</b>	1	EcoCondens SLIM WKD INT EcoCondens SLIM WKD PWM EcoCondens SLIM WKJ INT EcoCondens SLIM WKJ PWM

**HYDROBLOK Z POMPA PWM (KOTŁY JEDNOFUNKCYJNE)/HYDRAULIC GROUP WITH PWM PUMP  
(SYSTEM BOILER)/HYDROBLOCK MIT PWN PUMPE (EINFUNKTIONKESSEL)/ГИДРОБЛОК С НАСОСОМ  
PWN (КОТЛЫ ОДНОКОНТУРНЫЕ)**

rysunek/ drawing/ Zeichnung/ рисунок/ figura

**H1 -  
2740.01.00  
.00**

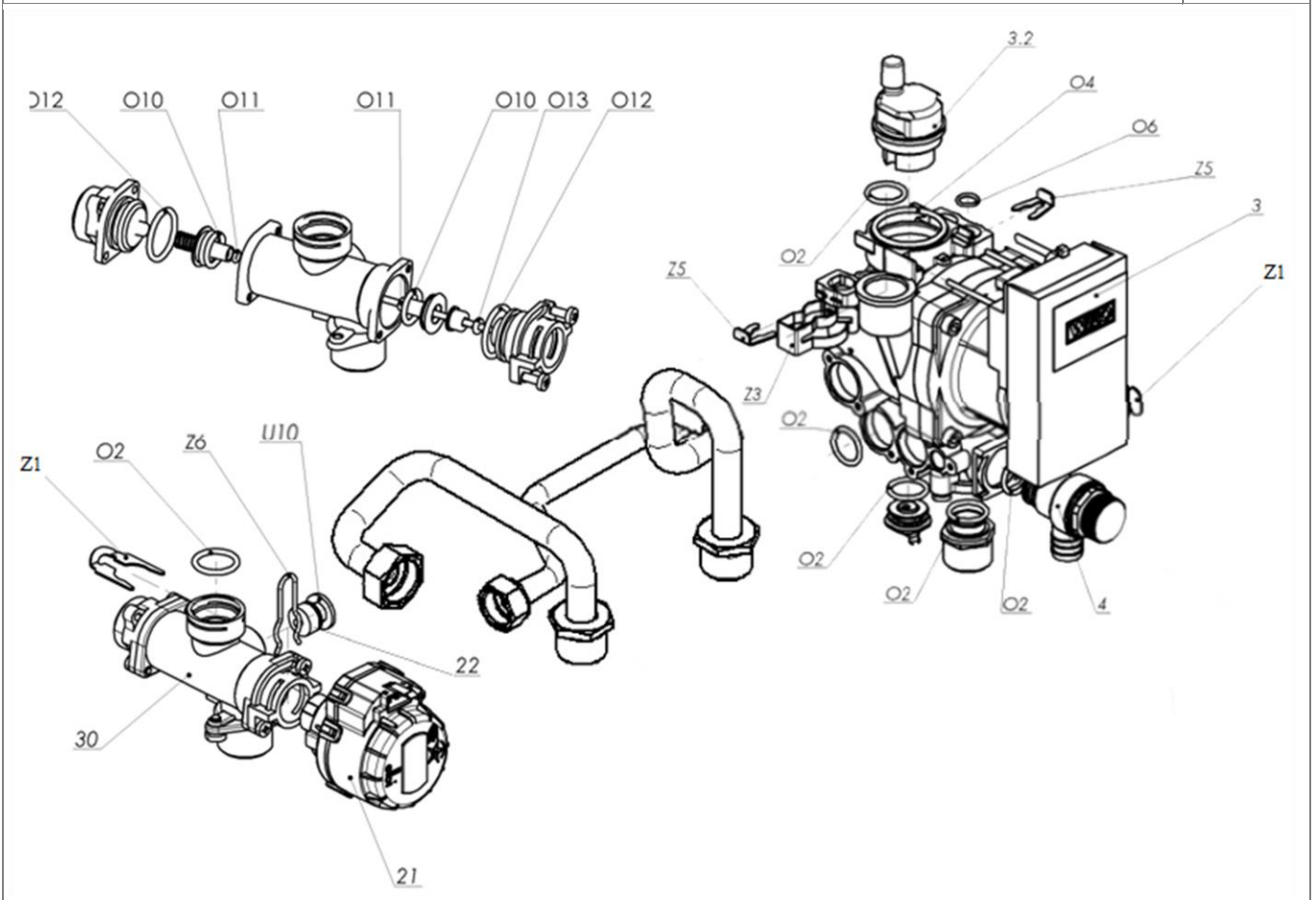

**HYDROBLOK Z POMPA INT (KOTŁY JEDNOFUNKCYJNE)/HYDRAULIC GROUP WITH INT PUMP  
(SYSTEM BOILER)/HYDROBLOCK MIT INT PUMPE (EINFUNKTIONKESSEL)/ГИДРОБЛОК С НАСОСOM  
INT (КОТЛЫ ОДНОКОНТУРНЫЕ)**

rysunek/ drawing/ Zeichnung/ рисунок/ figura

**H2 -  
2660.01.00  
.00**

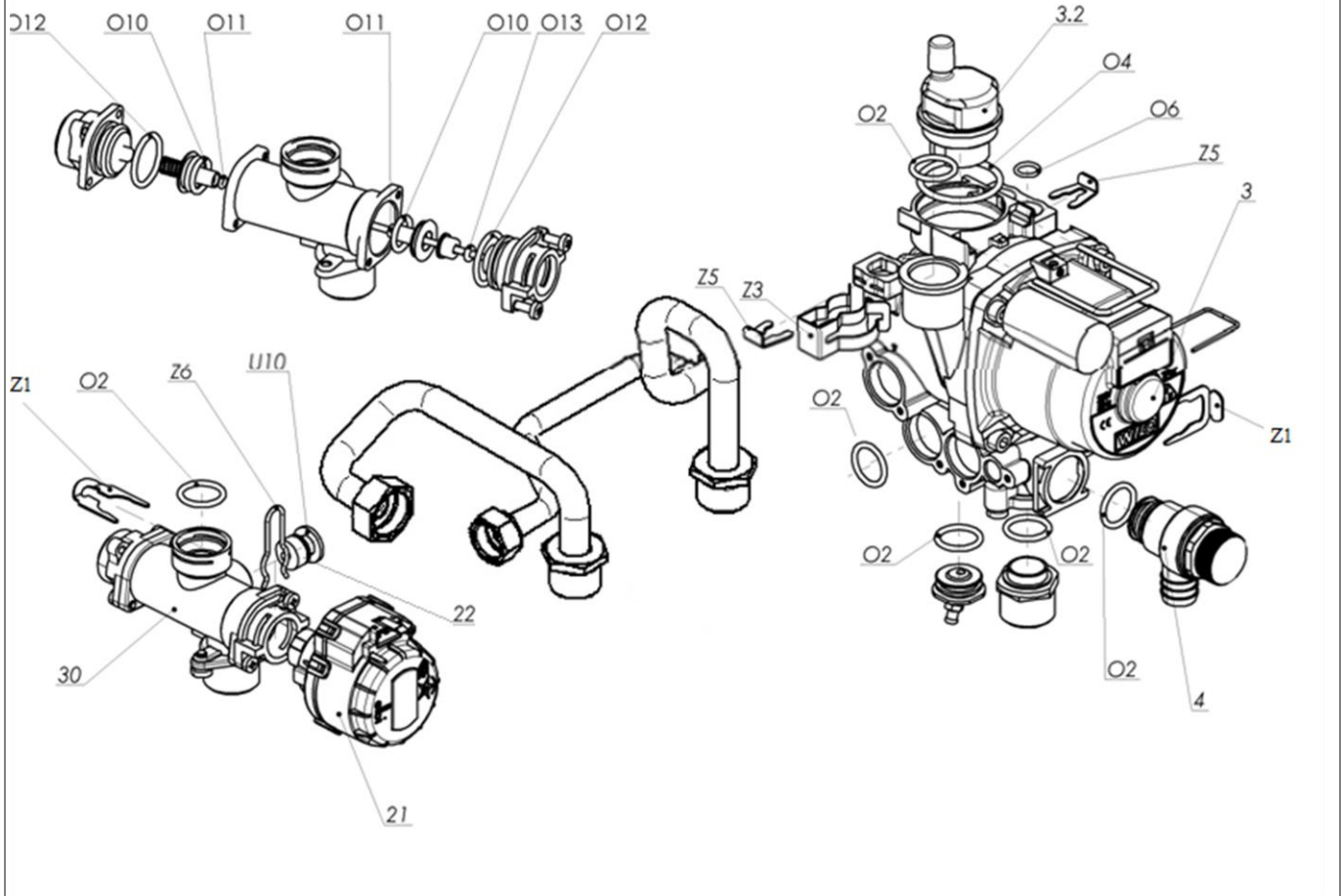

**HYDROBLOK Z POMPA PWM (KOTŁY DWUFUNKCYJNE)/HYDRAULIC GROUP WITH PWM PUMP  
(COMBI BOILER)/HYDROBLOCK MIT PWN PUMPE (ZWEIFUNKTIONKESSEL)/ГИДРОБЛОК С  
НАСОСОМ PWN (КОТЛЫ ДВУХКОНТУРНЫЕ)**

rysunek/ drawing/ Zeichnung/ рисунок/ figura

**H3 -  
2430.70.00  
.00**

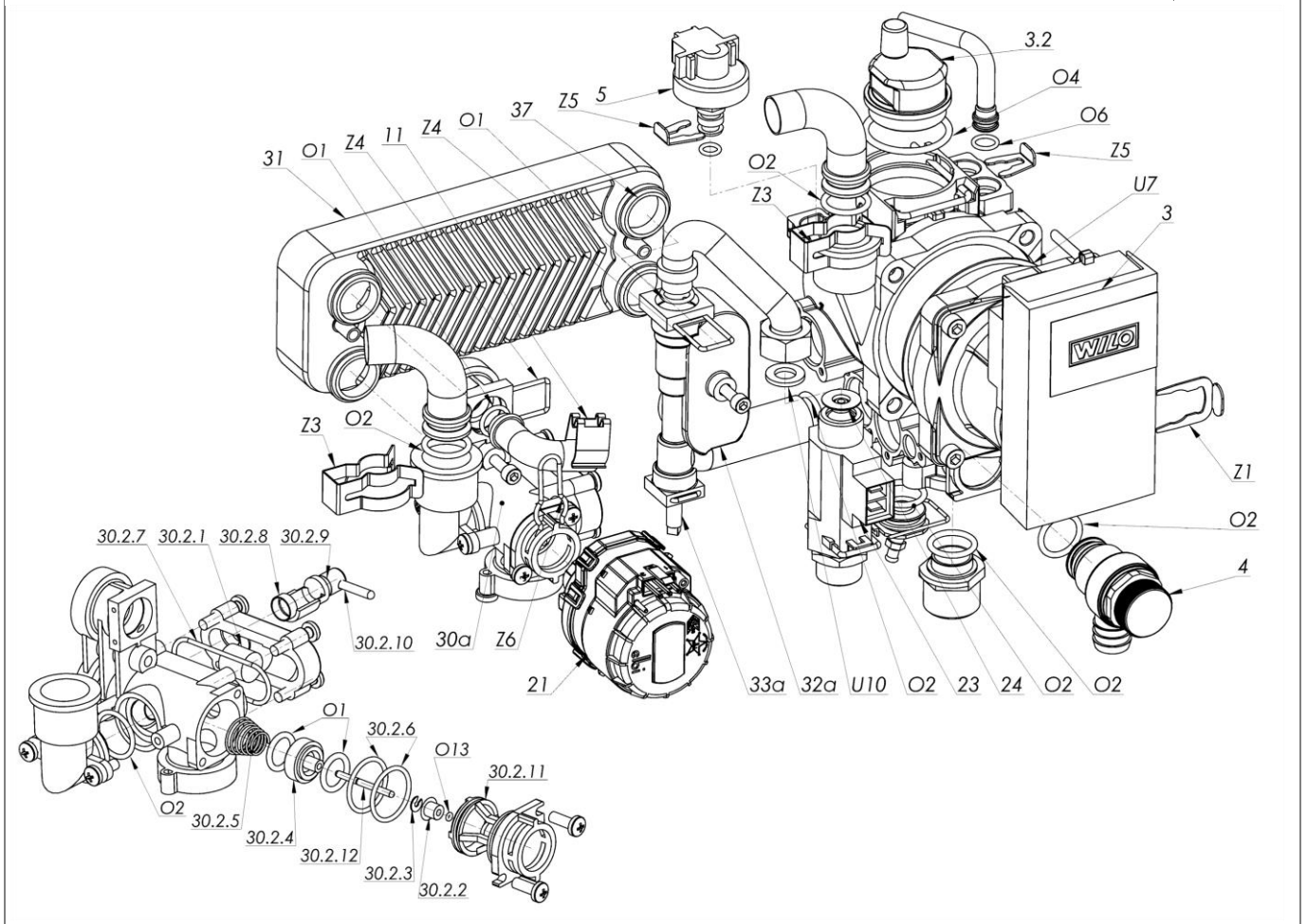



**HYDROBLOK Z POMPA INT (KOTŁY DWUFUNKCYJNE)/HYDRAULIC GROUP WITH INT PUMP (COMBI BOILER)/HYDROBLOCK MIT INT PUMPE (ZWEIFUNKTIONKESSEL)/ГИДРОБЛОК С НАСОСОМ INT (КОТЛЫ ДВУХКОНТУРНЫЕ)**

rysunek/ drawing/ Zeichnung/ рисунок/ figura

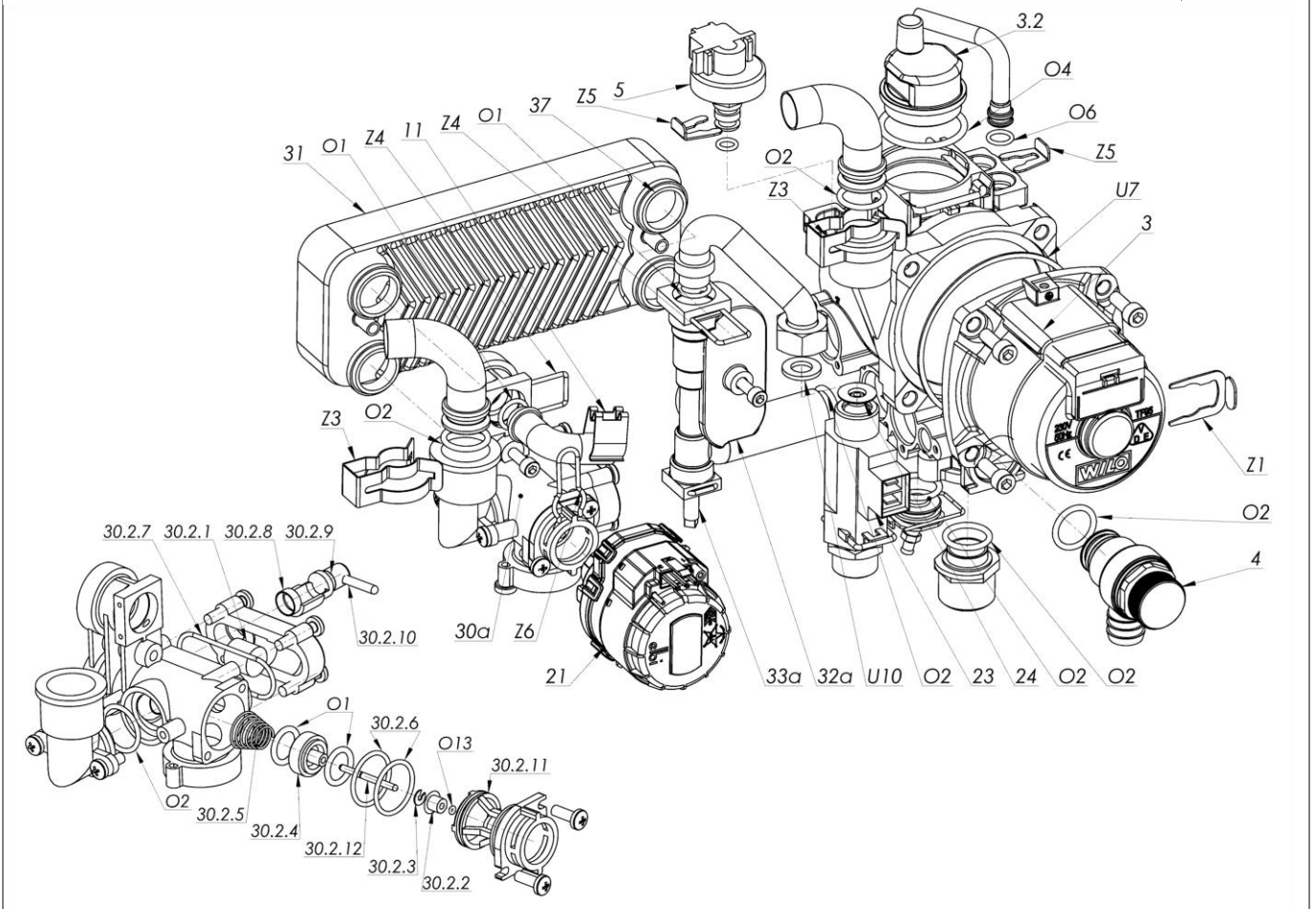
**H4 -  
1640.60.00  
.00**





PL	<b>ZAWÓR DO NAPEŁNIANIA</b>		
EN	<b>FILLING VALVE</b>		
DE	<b>FÜLLVENTIL</b>		
RU	<b>ЗАПРАВОЧНЫЙ КЛАПАН</b>		
IT	<b>VALVOLA RIEMPIMENTO</b>		
	ZAWÓR DO NAPEŁNIANIA		
	odnošnik/ reference/ Referenz/ ссылка/ riferimento		
widok/ view/ Ansicht/ вид/ vista	indeks/ index/ Index/ индекс/ codice	szt./ pcs/ Stck./ штук/ Pz.	zastosowanie/ application/ Anwendung/ применение/ funzionalità del ricambio
	<b>Z1490010240</b>	1	EcoCondens SLIM WKD INT EcoCondens SLIM WKD PWM  Na rysunku/ In the picture/ Auf dem Bild/ На рисунке/ In figura: <b>H3, H4</b>
zawiera/ contains/ Enthält/ содержит/ include			
Lp/ No/ Pos./ No/ No	nazwa/ name/ Name/ имя/ nome	indeks/ index/ Index/ индекс/ codice	szt./ pcs/ Stck./ штук/ Pz.
1	TRZPIEŃ, -, -, -, -, -	0700.01.03.03	1
2	Pokrętko, Knob, Drehknopf, Поворотная ручка	0700.01.03.08	1
3	TULEJA DOCISKOWA, Taper-Lock Bushing, Kegelsicherungsbuchse, Зажимная втулка, Boccola serratura	0700.01.03.06	1
4	USZCZELKA DO WODY, Water unit gasket, Dichtung der Wassereinheit, Прокладка для воды, Guarnizione per gruppo acqua	0700.01.03.02	1
5	USZCZELKA DO WODY, Water unit gasket, Dichtung der Wassereinheit, Прокладка для воды, Guarnizione per gruppo acqua	0700.01.03.04	1
6	USZCZELKA DO WODY, Water unit gasket, Dichtung der Wassereinheit, Прокладка для воды, Guarnizione per gruppo acqua	0700.01.00.10	1
7	ZAWÓR DO NAPEŁNIANIA, Filling valve, Füllventil, Заправочный клапан, Valvola riempimento	Screw M4x6	1

PL	<b>O-RING</b>		
EN	<b>O-RING</b>		
DE	<b>O-RING</b>		
RU	<b>О-КОЛЬЦО</b>		
IT	<b>O-RING</b>		
	<b>USZCZELKA DO WODY</b>		
<b>O1</b>	odnośnik/ reference/ Referenz/ ссылка/ riferimento		
widok/ view/ Ansicht/ вид/ vista	indeks/ index/ Index/ индекс/ codice	szt./ pcs/ Stck./ штук/ Pz.	zastosowanie/ application/ Anwendung/ применение/ funzionalità del ricambio
	<b>Z0700010011</b> typ/ type/ Тип/ тип/ tipo: <b>Ø13.95 x 2.62</b>	3	EcoCondens SLIM WKD INT EcoCondens SLIM WKD PWM  Na rysunku/ In the picture/ Auf dem Bild/ На рисунке/ In figura: <b>H3, H4</b>
	uwagi/ remarks/ Bemerkungen/ замечания/ commenti		
	1. Połączenie rurki z.w.u.z hydroblokiem 2. Połączenie rurki c.w.u. z hydroblokiem 3. Połączenie rurki by-pass z hydroblokiem 1. To connect a pipe of domestic cold water with a hydraulic group 2. To connect a pipe of domestic hot water with a hydraulic group 3. To connect a by – pass pipe with a hydraulic group  Опаковка zawiera/ The package contains/ Das Paket enthält/ Упаковка содержит/ La confezione include: 10 szt./ pcs/ Stck./ штук/ Pz.		





PL	<b>O-RING</b>		
EN	<b>O-RING</b>		
DE	<b>O-RING</b>		
RU	<b>О-КОЛЬЦО</b>		
IT	<b>O-RING</b>		
<b>USZCZELKA DO WODY</b>			
<b>02, 04</b>	odnośnik/ reference/ Referenz/ ссылка/ riferimento		
widok/ view/ Ansicht/ вид/ vista	indeks/ index/ Index/ индекс/ codice	szt./ pcs/ Stck./ штук/ Pz.	zastosowanie/ application/ Anwendung/ применение/ funzionalità del ricambio
	<b>Z0700010014</b> typ/ type/ Тип/ тип/ tipo: <b>Ø17,86 x 2.62</b>	<b>7</b>	EcoCondens SLIM WKD INT EcoCondens SLIM WKD PWM EcoCondens SLIM WKJ INT EcoCondens SLIM WKJ PWM  Na rysunku/ In the picture/ Auf dem Bild/ На рисунке/ In figura: <b>R1, R2, R3, R4, H1, H2, H3, H4</b>
uwagi/ remarks/ Bemerkungen/ замечания/ commenti			
<p>2 uds./pcs./шт. Stück</p> <p>1. Uszczelnienie rur z wymiennikiem spalin – woda 1. To seal connections between pipes and a flue-gas - water heat exchanger</p> <p>1 uds./pcs./шт. Stück</p> <p>2. Uszczelnienie zaworu bezpieczeństwa 2. To seal the safety valve</p> <p>1 uds./pcs./шт. Stück</p> <p>3. Uszczelnienie króćca pompy 3. To seal the pump's connector</p> <p>2 uds./pcs./шт. Stück.</p> <p>4. Uszczelnienie pompy z hydroblokiem 4. To seal a connection between a pump and a hydraulic group</p> <p>1 uds./pcs./шт. Stück.</p> <p>5. Uszczelnienie rury z hydroblokiem 5. To seal a connection between a pipe and a hydraulic group</p> <p>Opakowanie zawiera/ The package contains/ Das Paket enthält/ Упаковка содержит/ La confezione include: 10 szt./ pcs/ Stck./ штук/ Pz.</p>			

PL EN DE RU IT	<b>O-RING</b> <b>O-RING</b> <b>O-RING</b> <b>O-КОЛЬЦО</b> <b>O-RING</b>	<b>USZCZELKA DO WODY</b>		
<b>O5</b>	odnośnik/ reference/ Referenz/ ссылка/ riferimento			
widok/ view/ Ansicht/ вид/ vista	indeks/ index/ Index/ индекс/ codice	szt./ pcs/ Stck./ штук/ Pz.	zastosowanie/ application/ Anwendung/ применение/ funzionalità del ricambio	
	<b>Z0700010015</b> typ/ type/ Тип/ тип/ tipo: <b>Ø6,75 x Ø1,78</b>	1	EcoCondens SLIM WKD INT EcoCondens SLIM WKD PWM EcoCondens SLIM WKJ INT EcoCondens SLIM WKJ PWM  Na rysunku/ In the picture/ Auf dem Bild/ На рисунке/ In figura: <b>R1, R2, R3, R4</b>	
uwagi/ remarks/ Bemerkungen/ замечания/ commenti				
1. Uszczelnienie przetwornika ciśnienia 1. To seal of an pressure transducer				
Opakowanie zawiera/ The package contains/ Das Paket enthält/ Упаковка содержит/ La confezione include: 10 szt./ pcs/ Stck./ штук/ Pz.				

PL EN DE RU IT	<b>O-RING</b> <b>O-RING</b> <b>O-RING</b> <b>O-КОЛЬЦО</b> <b>O-RING</b>	<b>USZCZELKA DO WODY</b>		
<b>O6</b>	odnośnik/ reference/ Referenz/ ссылка/ riferimento			
widok/ view/ Ansicht/ вид/ vista	indeks/ index/ Index/ индекс/ codice	szt./ pcs/ Stck./ штук/ Pz.	zastosowanie/ application/ Anwendung/ применение/ funzionalità del ricambio	
	<b>Z0700010010</b> typ/ type/ Тип/ тип/ tipo: <b>Ø9,25 x Ø1,78</b>	2	EcoCondens SLIM WKD INT EcoCondens SLIM WKD PWM EcoCondens SLIM WKJ INT EcoCondens SLIM WKJ PWM  Na rysunku/ In the picture/ Auf dem Bild/ На рисунке/ In figura: <b>R1, R2, R3, R4, R5, H1, H2, H3, H4</b>	
uwagi/ remarks/ Bemerkungen/ замечания/ commenti				
1. Uszczelnienie rurki naczynia kompensacyjnego. 2. Uszczelnienie zaworu do napełniania 1. To seal a pipe of a compensation tank. 2. To seal a filling valve's				
Opakowanie zawiera/ The package contains/ Das Paket enthält/ Упаковка содержит/ La confezione include: 10 szt./ pcs/ Stck./ штук/ Pz.				

PL EN DE RU IT	<b>O-RING</b> <b>O-RING</b> <b>O-RING</b> <b>O-КОЛЬЦО</b> <b>O-RING</b>	<b>USZCZELKA DO WODY</b>		
<b>O8</b>	odnośnik/ reference/ Referenz/ ссылка/ riferimento			
widok/ view/ Ansicht/ вид/ vista	indeks/ index/ Index/ индекс/ codice	szt./ pcs/ Stck./ штук/ Pz.	zastosowanie/ application/ Anwendung/ применение/ funzionalità del ricambio	
	<b>Z0700010302</b> typ/ type/ Тип/ тип/ tipo: <b>Ø1,8 x Ø2,65</b>	1	EcoCondens SLIM WKD INT EcoCondens SLIM WKD PWM  Na rysunku/ In the picture/ Auf dem Bild/ На рисунке/ In figura: <b>R5</b>	
uwagi/ remarks/ Bemerkungen/ замечания/ commenti  1. Uszczelnienie trzpienia zaworu do napełniania 1. To seal a filling valve's stem  Opakowanie zawiera/ The package contains/ Das Paket enthält/ Упаковка содержит/ La confezione include: 10 szt./ pcs/ Stck./ штук/ Pz.				

PL EN DE RU IT	<b>O-RING</b> <b>O-RING</b> <b>O-RING</b> <b>O-КОЛЬЦО</b> <b>O-RING</b>	<b>USZCZELKA DO WODY</b>		
<b>O9</b>	odnośnik/ reference/ Referenz/ ссылка/ riferimento			
widok/ view/ Ansicht/ вид/ vista	indeks/ index/ Index/ индекс/ codice	szt./ pcs/ Stck./ штук/ Pz.	zastosowanie/ application/ Anwendung/ применение/ funzionalità del ricambio	
	<b>Z0700010304</b> typ/ type/ Тип/ тип/ tipo: <b>Ø5,28 x Ø1,78</b>	1	EcoCondens SLIM WKD INT EcoCondens SLIM WKD PWM  Na rysunku/ In the picture/ Auf dem Bild/ На рисунке/ In figura: <b>R5</b>	
uwagi/ remarks/ Bemerkungen/ замечания/ commenti  1. Uszczelnienie trzpienia zaworu do napełniania 1. To seal a filling valve's stem  Opakowanie zawiera/ The package contains/ Das Paket enthält/ Упаковка содержит/ La confezione include: 10 szt./ pcs/ Stck./ штук/ Pz.				

PL	<b>O-RING</b>			
EN	<b>O-RING</b>			
DE	<b>O-RING</b>			
RU	<b>О-КОЛЬЦО</b>			
IT	<b>O-RING</b>			
	<b>ORING</b>			
<b>O10</b>	odnošnik/ reference/ Referenz/ ссылка/ riferimento			
widok/ view/ Ansicht/ вид/ vista	indeks/ index/ Index/ индекс/ codice	szt./ pcs/ Stck./ штук/ Pz.	zastosowanie/ application/ Anwendung/ применение/ funzionalità del ricambio	
	<b>Z0700010111</b> typ/ type/ Тип/ тип/ tipo: <b>Ø13,1 x Ø2,62</b> kod/ code/ Code/ код/ codice: <b>21000 6967 00400</b>	2	EcoCondens SLIM WKJ INT EcoCondens SLIM WKJ PWM  Na rysunku/ In the picture/ Auf dem Bild/ На рисунке/ In figura: <b>H1, H2</b>	
uwagi/ remarks/ Bemerkungen/ замечания/ commenti				
1. Uszczelnienie korpusu zaworu trójdrogowego. 1. To seal a 3-way valve body.				
Opakowanie zawiera/ The package contains/ Das Paket enthält/ Упаковка содержит/ La confezione include: 10 szt./ pcs/ Stck./ штук/ Pz.				

PL	<b>O-RING</b>			
EN	<b>O-RING</b>			
DE	<b>O-RING</b>			
RU	<b>О-КОЛЬЦО</b>			
IT	<b>O-RING</b>			
	<b>ORING</b>			
<b>O11</b>	odnošnik/ reference/ Referenz/ ссылка/ riferimento			
widok/ view/ Ansicht/ вид/ vista	indeks/ index/ Index/ индекс/ codice	szt./ pcs/ Stck./ штук/ Pz.	zastosowanie/ application/ Anwendung/ применение/ funzionalità del ricambio	
	<b>Z0700010110</b> typ/ type/ Тип/ тип/ tipo: <b>Ø2,9 x Ø1,78</b> kod/ code/ Code/ код/ codice: <b>21000 6067 00300</b>	2	EcoCondens SLIM WKJ INT EcoCondens SLIM WKJ PWM  Na rysunku/ In the picture/ Auf dem Bild/ На рисунке/ In figura: <b>H1, H2</b>	
uwagi/ remarks/ Bemerkungen/ замечания/ commenti				
1. Uszczelnienie korpusu zaworu trójdrogowego. 1. To seal a 3-way valve body.				
Opakowanie zawiera/ The package contains/ Das Paket enthält/ Упаковка содержит/ La confezione include: 10 szt./ pcs/ Stck./ штук/ Pz.				

PL EN DE RU IT	<b>O-RING</b> <b>O-RING</b> <b>O-RING</b> <b>O-КОЛЬЦО</b> <b>O-RING</b>			
	ORING			
<b>O12</b>	odnošnik/ reference/ Referenz/ ссылка/ riferimento			
widok/ view/ Ansicht/ вид/ vista	indeks/ index/ Index/ индекс/ codice	szt./ pcs/ Stck./ штук/ Pz.	zastosowanie/ application/ Anwendung/ применение/ funzionalità del ricambio	
	<b>Z0700010106</b> typ/ type/ Тип/ тип/ tipo: <b>Ø21,89 x Ø2,62</b> kod/ code/ Code/ код/ codice: <b>00046 240 230360</b>	2	EcoCondens SLIM WKJ INT EcoCondens SLIM WKJ PWM  Na rysunku/ In the picture/ Auf dem Bild/ На рисунке/ In figura: <b>H1, H2</b>	
uwagi/ remarks/ Bemerkungen/ замечания/ commenti				
1. Uszczelnienie tulejek zewnętrznych zaworu trójdrożnego 1. To seal external muffs of a 3 – way valve				
Opakowanie zawiera/ The package contains/ Das Paket enthält/ Упаковка содержит/ La confezione include: 10 szt./ pcs/ Stck./ штук/ Pz.				

PL EN DE RU IT	<b>O-RING</b> <b>O-RING</b> <b>O-RING</b> <b>O-КОЛЬЦО</b> <b>O-RING</b>			
	ORING			
<b>O13</b>	odnošnik/ reference/ Referenz/ ссылка/ riferimento			
widok/ view/ Ansicht/ вид/ vista	indeks/ index/ Index/ индекс/ codice	szt./ pcs/ Stck./ штук/ Pz.	zastosowanie/ application/ Anwendung/ применение/ funzionalità del ricambio	
	<b>Z0700010105</b> typ/ type/ Тип/ тип/ tipo: <b>Ø2,84 x Ø2,62</b> kod/ code/ Code/ код/ codice: <b>00046 240 230310</b>	1	EcoCondens SLIM WKD INT EcoCondens SLIM WKD PWM EcoCondens SLIM WKJ INT EcoCondens SLIM WKJ PWM  Na rysunku/ In the picture/ Auf dem Bild/ На рисунке/ In figura: <b>H1, H2, H3, H4</b>	
uwagi/ remarks/ Bemerkungen/ замечания/ commenti				
1. Uszczelnienie osi zaworu trójdrożnego 1. To seal of an axle of a 3 – way valve				
Opakowanie zawiera/ The package contains/ Das Paket enthält/ Упаковка содержит/ La confezione include: 10 szt./ pcs/ Stck./ штук/ Pz.				

PL	<b>O-RING</b>			
EN	<b>O-RING</b>			
DE	<b>O-RING</b>			
RU	<b>О-КОЛЬЦО</b>			
IT	<b>O-RING</b>			
		<b>PIERŚCIEŃ USZCZELNIAJĄCY 28X2,2</b>		
<b>O18</b>	odnośnik/ reference/ Referenz/ ссылка/ riferimento			
widok/ view/ Ansicht/ вид/ vista	indeks/ index/ Index/ индекс/ codice	szt./ pcs/ Stck./ штук/ Pz.	zastosowanie/ application/ Anwendung/ применение/ funzionalità del ricambio	
	<b>Z4350090103</b>	1	EcoCondens SLIM WKD INT EcoCondens SLIM WKD PWM EcoCondens SLIM WKJ INT EcoCondens SLIM WKJ PWM  Na rysunku/ In the picture/ Auf dem Bild/ На рисунке/ In figura: <b>R1, R2, R3, R4</b>	
uwagi/ remarks/ Bemerkungen/ замечания/ commenti				
1. Uszczelnienie syfonu. 1. Уплотнение сифона 1. guarnizione del sifone 1. siphon sealing 1. Siphondichtung				

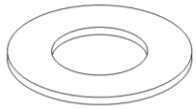
PL	<b>USZCZELKA</b>			
EN	<b>GASKET</b>			
DE	<b>DICHTUNG</b>			
RU	<b>ПРОКЛАДКА</b>			
IT	<b>GUARNIZIONE</b>			
		<b>USZCZELKA GAMBITOWA FI24X16X2</b>		
<b>U1</b>	odnośnik/ reference/ Referenz/ ссылка/ riferimento			
widok/ view/ Ansicht/ вид/ vista	indeks/ index/ Index/ индекс/ codice	szt./ pcs/ Stck./ штук/ Pz.	zastosowanie/ application/ Anwendung/ применение/ funzionalità del ricambio	
	<b>Z0560000026</b>  typ/ type/ Тип/ тип/ tipo: <b>Ø24xØ16x2</b>	1	EcoCondens SLIM WKD INT EcoCondens SLIM WKD PWM EcoCondens SLIM WKJ INT EcoCondens SLIM WKJ PWM  Na rysunku/ In the picture/ Auf dem Bild/ На рисунке/ In figura: <b>R1, R2, R3, R4</b>	
uwagi/ remarks/ Bemerkungen/ замечания/ commenti				
1. Połączenie rury gazowej z króćcem 1. To connect a gas pipe with a connector  Opakowanie zawiera/ The package contains/ Das Paket enthält/ Упаковка содержит/ La confezione include: 10 szt./ pcs/ Stck./ штук/ Pz.				

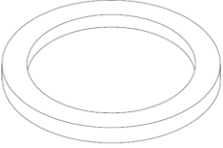
PL	<b>USZCZELKA</b>			
EN	<b>GASKET</b>			
DE	<b>DICHTUNG</b>			
RU	<b>ПРОКЛАДКА</b>			
IT	<b>GUARNIZIONE</b>			
	<b>USZCZELKA</b>			
<b>U2</b>	odnošnik/ reference/ Referenz/ ссылка/ riferimento			
widok/ view/ Ansicht/ вид/ vista	indeks/ index/ Index/ индекс/ codice	szt./ pcs/ Stck./ штук/ Pz.	zastosowanie/ application/ Anwendung/ применение/ funzionalità del ricambio	
	<b>Z0370000009</b> typ/ type/ Тип/ тип/ tipo: <b>Ø24xØ16x2</b>	1	EcoCondens SLIM WKJ INT EcoCondens SLIM WKJ PWM  Na rysunku/ In the picture/ Auf dem Bild/ На рисунке/ In figura: <b>R3, R4</b>	
uwagi/ remarks/ Bemerkungen/ замечания/ commenti				
1. Uszczelnienie rury na złączce w hydrobloku 1. To seal a pipe on a connector in a hydroblock				
Opakowanie zawiera/ The package contains/ Das Paket enthält/ Упаковка содержит/ La confezione include: 10 szt./ pcs/ Stck./ штук/ Pz.				

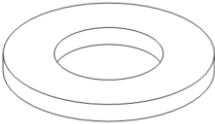
PL	<b>USZCZELKA</b>			
EN	<b>GASKET</b>			
DE	<b>DICHTUNG</b>			
RU	<b>ПРОКЛАДКА</b>			
IT	<b>GUARNIZIONE</b>			
	<b>USZCZELKA</b>			
<b>U3</b>	odnošnik/ reference/ Referenz/ ссылка/ riferimento			
widok/ view/ Ansicht/ вид/ vista	indeks/ index/ Index/ индекс/ codice	szt./ pcs/ Stck./ штук/ Pz.	zastosowanie/ application/ Anwendung/ применение/ funzionalità del ricambio	
	<b>Z0560000027</b> typ/ type/ Тип/ тип/ tipo: <b>Ø14,8xØ10x2</b>	1	EcoCondens SLIM WKD INT EcoCondens SLIM WKD PWM EcoCondens SLIM WKJ INT EcoCondens SLIM WKJ PWM  Na rysunku/ In the picture/ Auf dem Bild/ На рисунке/ In figura: <b>R1, R2, R3, R4</b>	
uwagi/ remarks/ Bemerkungen/ замечания/ commenti				
1. Połączenie rurki z naczyniem wzbiórczym 1. To connect a pipe with a compensation tank				
Opakowanie zawiera/ The package contains/ Das Paket enthält/ Упаковка содержит/ La confezione include: 10 szt./ pcs/ Stck./ штук/ Pz.				

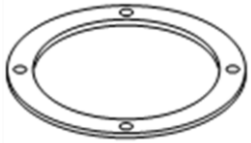
PL	<b>USZCZELKA</b>			
EN	<b>GASKET</b>			
DE	<b>DICHTUNG</b>			
RU	<b>ПРОКЛАДКА</b>			
IT	<b>GUARNIZIONE</b>			
	<b>USZCZELKA SAMOPRZYLEPNA</b>			
<b>U4</b>	odnošnik/ reference/ Referenz/ ссылка/ riferimento			
widok/ view/ Ansicht/ вид/ vista	indeks/ index/ Index/ индекс/ codice	szt./ pcs/ Stck./ штук/ Pz.	zastosowanie/ application/ Anwendung/ применение/ funzionalità del ricambio	
	<b>Z2730000001</b>	1	EcoCondens SLIM WKD INT EcoCondens SLIM WKD PWM EcoCondens SLIM WKJ INT EcoCondens SLIM WKJ PWM  Na rysunku/ In the picture/ Auf dem Bild/ На рисунке/ In figura: <b>R1, R2, R3, R4</b>	
uwagi/ remarks/ Bemerkungen/ замечания/ commenti				
1. Uszczelnienie pokrywy w płycie górnej 1. To seal a cover in an upper plate				

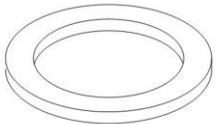
PL	<b>USZCZELKA</b>			
EN	<b>GASKET</b>			
DE	<b>DICHTUNG</b>			
RU	<b>ПРОКЛАДКА</b>			
IT	<b>GUARNIZIONE</b>			
	<b>USZCZELKA</b>			
<b>U10</b>	odnošnik/ reference/ Referenz/ ссылка/ riferimento			
widok/ view/ Ansicht/ вид/ vista	indeks/ index/ Index/ индекс/ codice	szt./ pcs/ Stck./ штук/ Pz.	zastosowanie/ application/ Anwendung/ применение/ funzionalità del ricambio	
	<b>Z0700010016</b> typ/ type/ Тип/ тип/ tipo: <b>Ø18 x Ø10 x 2</b>	2	EcoCondens SLIM WKD INT EcoCondens SLIM WKD PWM  Na rysunku/ In the picture/ Auf dem Bild/ На рисунке/ In figura: <b>H3, H4</b>	
uwagi/ remarks/ Bemerkungen/ замечания/ commenti				
1. Połączenie rurki z czujnikiem przepływu w.u. 2. Uszczelnienie rury by – pass. 1. To connect a pipe with a domestic water flow switch 2. To seal a by-pass pipe				
Opakowanie zawiera/ The package contains/ Das Paket enthält/ Упаковка содержит/ La confezione include: 10 szt./ pcs/ Stck./ штук/ Pz.				

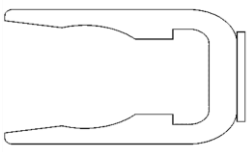

PL	<b>ZAPINKA</b>			
EN	<b>CLAMP</b>			
DE	<b>KLEMME</b>			
RU	<b>КЛИПСА</b>			
IT	<b>MOLLA FISSAGGIO</b>			
	ZAPINKA I			
<b>Z1</b>	odnošnik/ reference/ Referenz/ ссылка/ riferimento			
widok/ view/ Ansicht/ вид/ vista	indeks/ index/ Index/ индекс/ codice	szt./ pcs/ Stck./ штук/ Pz.	zastosowanie/ application/ Anwendung/ применение/ funzionalità del ricambio	
	<b>Z0700010003</b>	2	EcoCondens SLIM WKD INT EcoCondens SLIM WKD PWM EcoCondens SLIM WKJ INT EcoCondens SLIM WKJ PWM  Na rysunku/ In the picture/ Auf dem Bild/ На рисунке/ In figura: <b>R3, R4, H1, H2, H3, H4</b>	
uwagi/ remarks/ Bemerkungen/ замечания/ commenti				
1. Mocowanie rur c.o. w hydrobloku (tylko w WKJ) 2. Mocowanie zaworu bezpieczeństwa 1. To fasten a pipe of heating water in a hydraulicgroup 2. To fasten a safety valve.				
Opakowanie zawiera/ The package contains/ Das Paket enthält/ Упаковка содержит/ La confezione include: 10 szt./ pcs/ Stck./ штук/ Pz.				

PL	<b>ZAPINKA</b>			
EN	<b>CLAMP</b>			
DE	<b>KLEMME</b>			
RU	<b>КЛИПСА</b>			
IT	<b>MOLLA FISSAGGIO</b>			
	ZAPINKA			
<b>Z2</b>	odnošnik/ reference/ Referenz/ ссылка/ riferimento			
widok/ view/ Ansicht/ вид/ vista	indeks/ index/ Index/ индекс/ codice	szt./ pcs/ Stck./ штук/ Pz.	zastosowanie/ application/ Anwendung/ применение/ funzionalità del ricambio	
	<b>Z4350050102</b>	1	EcoCondens SLIM WKD INT EcoCondens SLIM WKD PWM EcoCondens SLIM WKJ INT EcoCondens SLIM WKJ PWM  Na rysunku/ In the picture/ Auf dem Bild/ На рисунке/ In figura: <b>R1, R2, R3, R4</b>	

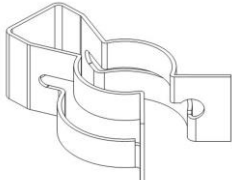
PL EN DE RU IT	<b>KLIPS</b> <b>CLIP</b> <b>KLAMMER</b> <b>КЛИПСА</b> <b>CLIP</b>	KLIPS Ø18/Ø30		
<b>Z3</b>	odnośnik/ reference/ Referenz/ ссылка/ riferimento			
widok/ view/ Ansicht/ вид/ vista	indeks/ index/ Index/ индекс/ codice	szt./ pcs/ Stck./ штук/ Pz.	zastosowanie/ application/ Anwendung/ применение/ funzionalità del ricambio	
	<b>Z1480500020</b> kod/ code/ Code/ код/ codice: <b>21000 6070 00900</b>	2	EcoCondens SLIM WKD INT EcoCondens SLIM WKD PWM EcoCondens SLIM WKJ INT EcoCondens SLIM WKJ PWM  Na rysunku/ In the picture/ Auf dem Bild/ На рисунке/ In figura: <b>R1, R2, R3, R4, H1, H2, H3, H4</b>	
uwagi/ remarks/ Bemerkungen/ замечания/ commenti				
1. Mocowanie rury c.o. w hydrobloku 1. To fasten a pipe of heating water in a hydraulic group				
Opakowanie zawiera/ The package contains/ Das Paket enthält/ Упаковка содержит/ La confezione include: 10 szt./ pcs/ Stck./ штук/ Pz.				

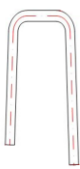
PL EN DE RU IT	<b>ZAPINKA</b> <b>CLAMP</b> <b>KLEMME</b> <b>КЛИПСА</b> <b>MOLLA FISSAGGIO</b>	ZAPINKA IV		
<b>Z4</b>	odnośnik/ reference/ Referenz/ ссылка/ riferimento			
widok/ view/ Ansicht/ вид/ vista	indeks/ index/ Index/ индекс/ codice	szt./ pcs/ Stck./ штук/ Pz.	zastosowanie/ application/ Anwendung/ применение/ funzionalità del ricambio	
	<b>Z0700010006</b>	2	EcoCondens SLIM WKD INT EcoCondens SLIM WKD PWM  Na rysunku/ In the picture/ Auf dem Bild/ На рисунке/ In figura: <b>H3, H4</b>	
uwagi/ remarks/ Bemerkungen/ замечания/ commenti				
1. Mocowanie rury c.w.u. w hydrobloku 2. Mocowanie rury z.w.u. w hydrobloku 1. To fasten a pipe of domestic warm water in a hydraulic group 2. To fasten a pipe of domestic cold water in a hydraulic group				
Opakowanie zawiera/ The package contains/ Das Paket enthält/ Упаковка содержит/ La confezione include: 10 szt./ pcs/ Stck./ штук/ Pz.				

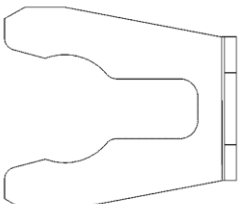
PL	<b>ZAPINKA</b>			
EN	<b>CLAMP</b>			
DE	<b>KLEMME</b>			
RU	<b>КЛИПСА</b>			
IT	<b>MOLLA FISSAGGIO</b>			
	ZAPINKA Ø 9			
<b>Z5</b>	odnośnik/ reference/ Referenz/ ссылка/ riferimento			
widok/ view/ Ansicht/ вид/ vista	indeks/ index/ Index/ индекс/ codice	szt./ pcs/ Stck./ штук/ Pz.	zastosowanie/ application/ Anwendung/ применение/ funzionalità del ricambio	
	<b>Z1480500019</b>	2	EcoCondens SLIM WKD INT EcoCondens SLIM WKD PWM EcoCondens SLIM WKJ INT EcoCondens SLIM WKJ PWM  Na rysunku/ In the picture/ Auf dem Bild/ На рисунке/ In figura: <b>H1, H2, H3, H4</b>	
uwagi/ remarks/ Bemerkungen/ замечания/ commenti				
1. Mocowanie przetwornika ciśnienia 2. Mocowanie rury zbiornika kompensacyjnego 1. To fasten a pressure transducer, 2. To fasten a pipe of a compensation tank.				
Opakowanie zawiera/ The package contains/ Das Paket enthält/ Упаковка содержит/ La confezione include: 10 szt./ pcs/ Stck./ штук/ Pz.				

PL	<b>ZAPINKA</b>			
EN	<b>CLAMP</b>			
DE	<b>KLEMME</b>			
RU	<b>КЛИПСА</b>			
IT	<b>MOLLA FISSAGGIO</b>			
	ZAPINKA III			
<b>Z6</b>	odnośnik/ reference/ Referenz/ ссылка/ riferimento			
widok/ view/ Ansicht/ вид/ vista	indeks/ index/ Index/ индекс/ codice	szt./ pcs/ Stck./ штук/ Pz.	zastosowanie/ application/ Anwendung/ применение/ funzionalità del ricambio	
	<b>Z0700010005</b>	1	EcoCondens SLIM WKD INT EcoCondens SLIM WKD PWM EcoCondens SLIM WKJ INT EcoCondens SLIM WKJ PWM  Na rysunku/ In the picture/ Auf dem Bild/ На рисунке/ In figura: <b>H1, H2, H3, H4</b>	
uwagi/ remarks/ Bemerkungen/ замечания/ commenti				
1. Mocowanie silnika zaworu trójdrogowego 1. To fasten an engine of 3-ways valve				
Opakowanie zawiera/ The package contains/ Das Paket enthält/ Упаковка содержит/ La confezione include:				

	10 szt./ pcs/ Stck./ штук/ Pz.
--	--------------------------------

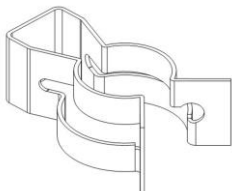
PL	<b>KLIPS</b>			
EN	<b>CLIP</b>			
DE	<b>KLAMMER</b>			
RU	<b>КЛИПСА</b>			
IT	<b>CLIP</b>			
	<b>KLIPS</b>			
<b>Z7</b>	odnošnik/ reference/ Referenz/ ссылка/ riferimento			
widok/ view/ Ansicht/ вид/ vista	indeks/ index/ Index/ индекс/ codice	szt./ pcs/ Stck./ штук/ Pz.	zastosowanie/ application/ Anwendung/ применение/ funzionalità del ricambio	
	<b>Z0720040012</b> typ/ type/ Тип/ тип/ tipo: <b>GM-10-35-078-03</b>	2	EcoCondens SLIM WKD INT EcoCondens SLIM WKD PWM EcoCondens SLIM WKJ INT EcoCondens SLIM WKJ PWM  Na rysunku/ In the picture/ Auf dem Bild/ На рисунке/ In figura: <b>R1, R2, R3, R4</b>	
uwagi/ remarks/ Bemerkungen/ замечания/ commenti				
1. Mocowanie rur c.o. w wymienniku ciepła 1. To fasten a pipe of heating water in a heat exchanger				
Opakowanie zawiera/ The package contains/ Das Paket enthält/ Упаковка содержит/ La confezione include: 1 szt./ pcs/ Stck./ штук/ Pz.				

PL	<b>USZCZELKI KOTŁA (ZESTAW NAPRAWCZY)</b>		
EN	<b>SET OF GASKETS (REPAIR KIT)</b>		
DE	<b>DICHTUNGSSATZ (REPARATURSATZ)</b>		
RU	<b>ПРОКЛАДКИ КОТЛА (РЕМОНТНЫЙ КОМПЛЕКТ)</b>		
IT	<b>SET DI GUARNIZIONI (KIT MANUTENZIONE)</b>		
	USZCZELKI DO KOTŁA		
	odnośnik/ reference/ Referenz/ ссылка/ riferimento		
widok/ view/ Ansicht/ вид/ vista	indeks/ index/ Index/ индекс/ codice	szt./ pcs/ Stck./ штук/ Pz.	zastosowanie/ application/ Anwendung/ применение/ funzionalità del ricambio
	<b>Z1780009900</b>	1	EcoCondens SLIM WKD INT EcoCondens SLIM WKD PWM EcoCondens SLIM WKJ INT EcoCondens SLIM WKJ PWM
zawiera/ contains/ Enthält/ содержит/ include			
Lp/ No/ Pos./ No/ No	nazwa/ name/ Name/ имя/ nome	indeks/ index/ Index/ индекс/ codice	szt./ pcs/ Stck./ штук/ Pz.
1	O-RING, O-Ring, O-ring, O-ring, O-кольцо	0700.01.00.14	8
2	O-RING, O-Ring, O-ring, O-ring, O-кольцо	0700.01.00.10	1
3	O-RING, O-Ring, O-ring, O-ring, O-кольцо	0850.00.00.08	1
4	O-RING, O-Ring, O-ring, O-ring, O-кольцо	0700.01.00.15	1
5	O-RING, O-Ring, O-ring, O-ring, O-кольцо	0700.00.00.08	1
6	O-RING, O-Ring, O-ring, O-ring, O-кольцо	0700.01.00.11	3
7	USZCZELKA, Gasket, Dichtung, Прокладка, Guarnizione	0560.00.00.27, 0300.00.00.13	1
8	USZCZELKA, Gasket, Dichtung, Прокладка, Guarnizione	0700.01.00.16	2
9	USZCZELKA, Gasket, Dichtung, Прокладка, Guarnizione	0950.10.00.12	1
10	O-RING, O-Ring, O-ring, O-ring, O-кольцо	0700.01.03.02	1
11	O-RING, O-Ring, O-ring, O-ring, O-кольцо	0700.01.03.04	1
12	O-RING, O-Ring, O-ring, O-ring, O-кольцо	0700.01.01.05	1
13	O-RING, O-Ring, O-ring, O-ring, O-кольцо	0700.01.01.06	2
14	O-RING, O-Ring, O-ring, O-ring, O-кольцо	0700.01.01.10	2
15	O-RING, O-Ring, O-ring, O-ring, O-кольцо	0700.01.01.11	2
16	O-RING, O-Ring, O-ring, O-ring, O-кольцо	0700.01.01.18	2
17	O-RING, O-Ring, O-ring, O-ring, O-кольцо	0700.01.01.21	2
18	O-RING, O-Ring, O-ring, O-ring, O-кольцо	0700.01.04.22	1
19	USZCZELKA, Gasket, Dichtung, Прокладка, Guarnizione	0700.01.04.12	1
20	USZCZELKA, Gasket, Dichtung, Прокладка, Guarnizione	0720.04.00.05	1
21	USZCZELKA, Gasket, Dichtung, Прокладка, Guarnizione	0720.05.00.02	1
22	USZCZELKA, Gasket, Dichtung, Прокладка, Guarnizione	0370.00.00.09	1
23	USZCZELKA, Gasket, Dichtung, Прокладка, Guarnizione	0700.01.00.06	2
24	USZCZELKA, Gasket, Dichtung, Прокладка, Guarnizione	0560.00.00.26	1
25	USZCZELKA, Gasket, Dichtung, Прокладка, Guarnizione	2450.60.00.14	4