

LG

THERMA V™

Air-to-Water Heat Pump / Monobloc

R32 / 50Hz

5BPM5-01A

TOTAL HVAC

SOLUTION

PROVIDER

ENGINEERING PRODUCT DATA BOOK

THERMA VTM
Monobloc Type

General Information

Product Data

Design and installation

THERMA VTM

Monobloc Type

General Information

- 1.Features**
- 2.Model Line Up**
- 3.Nomenclature**

1. Features

- High energy efficiency
- Easy installation
- Total solution for cooling, heating & hot water
- No refrigerant piping work
- Fit for renovation of old boiler system
- Low operating cost and CO₂ emission



< UN4 Chassis >



< UN3 Chassis >

2. Model line up

Category	Chassis	Model Name		
		Capacity (kW)		
		5.5	7.0	9.0
1 Phase Model 1 Ø, 220-240 V, 50 Hz	UN4	ZHBW056A0 [HM051M U43]	ZHBW076A0 [HM071M U43]	ZHBW096A0 [HM091M U43]

Category	Chassis	12.0	14.0	16.0
		1 Phase Model 1 Ø, 220-240 V, 50 Hz	UN3	ZHBW126A0 [HM121M U33]
3 Phase Model 3 Ø, 380-415 V, 50 Hz	ZHBW128A0 [HM123M U33]	ZHBW148A0 [HM143M U33]		ZHBW168A0 [HM163M U33]

3. Nomenclature

■ **Global Name**

Model Name	ZH	B	W	12	6	A	0
No.	1	2	3	4	5	6	7

No.	Signification
1	ZH : Air-to-Water Heat Pump for R32
2	Classification B : Monobloc
3	Model Type W : Inverter Heat Pump
4	Heating Capacity (kW) Ex) 5 kW : '05', 16 kW : '16'
5	Electrical ratings 6 : 1 Ø, 220-240 V, 50 Hz 8 : 3 Ø, 380-415 V, 50 Hz
6	Function A : General Heating Heat pump
7	Serial number

3. Nomenclature

■ **European Name**

Model Name	H	M	12	1	M	U3	3
No.	1	2	3	4	5	6	7

No.	Signification
1	H : Air-to-Water Heat Pump
2	Classification M : Monobloc type
3	Heating Capacity (kW) Ex) 5 kW : '05', 16 kW : '16'
4	Electrical ratings 1 : 1 Ø, 220-240 V, 50 Hz 3 : 3 Ø, 380-415 V, 50 Hz
5	Leaving Water Combination M : Middle Temperature
6	Platform (Chassis code) U3 : UN3 Chassis U4 : UN4 Chassis
7	Type of refrigerant 2 : R410A 3 : R32

THERMA VTM

Monobloc Type

Product Data

- 1. List of Functions**
- 2. Specification**
- 3. Dimensions**
- 4. Piping Diagrams**
- 5. Wiring Diagrams**
- 6. Performance Data**
- 7. Electric Characteristics**
- 8. Operation Range**
- 9. Sound levels**
- 10. Water Pump Capacity**

1. List of Functions

Basic functions of Unit

Water Side

Category	Functions	ZHBW056A0 [HM051M U43] ZHBW076A0 [HM071M U43] / ZHBW096A0 [HM091M U43] ZHBW126A0 [HM121M U33] / ZHBW128A0 [HM123M U33] ZHBW146A0 [HM141M U33] / ZHBW148A0 [HM143M U33] ZHBW166A0 [HM161M U33] / ZHBW168A0 [HM163M U33]
Installation	Backup heater (Install kit)	O (Accessory)
Reliability	Self diagnosis	O
Convenience	Auto Restart	O
	Child lock*	O
	Sleep mode	O
	Timer (on/off)	O
	Timer (weekly)*	O
	Two thermistor control	X
Air to Water Heat Pump Functions	Anti-condensation on floor (cooling)	O
	Water pump on / off Control	O
	Flow switch control	O
	Thermostat interface (230V AC)	O
	Thermostat interface (24V AC)	X
	DHW(Domestic Hot Water) Tank heater kit (Install kit)	O (Accessory)
	Solar thermal kit interface with DHW Tank	O (Accessory)
	PHEX anti-freezing control	O
	Water pump forced operation	O
	Autosetting according to ambient temperature	O
	Silent operation	O
	Anti-overheating of water pipe	O
	Emergency operation	O
	Weather Dependent Operation with Thermostat	O
	Scheduler (DHW Tank Heater)	O
	Timer (Domestic Hot Water Tank Heater)	O
	Quick Domestic Hot Water Tank Heating	O
	Backup Heater Capacity Control	O
	Screed Drying Mode	O
	Sump Heater	O
Base Pan Heater	O	
Dry Contact (Main PCB)	O	

Refrigerant Side

Category	Functions	ZHBW056A0 [HM051M U43] ZHBW076A0 [HM071M U43] ZHBW096A0 [HM091M U43] ZHBW126A0 [HM121M U33] ZHBW146A0 [HM141M U33] ZHBW166A0 [HM161M U33]	ZHBW128A0 [HM123M U33] ZHBW148A0 [HM143M U33] ZHBW168A0 [HM163M U33]
Reliability	Defrost / Deicing	O	O
	High pressure switch	O	O
	Low pressure switch	X	X
	Phase protection	X	O
	Restart delay (3-minutes)	O	O
	Self diagnosis	O	O
	Soft start	X	X
Convenience	Test function	X	X
	Night Low Noise Operation	O	O
	Wiring Error Check	X	X
	Peak Control	X	X
	Mode Lock	O	O
Network function	Forced Cooling Operation (Outdoor Unit)	X	X
	Network solution(LGAP)	O	O

Note

- O : Applied, X : Not applied
Accessory : Ordered and purchased separately the accessory package referring to the model name provided and install at field.
Accessory line-ups varies by region, so check your local catalogue or local sales material.
- * : These functions need to connect the wired remote controller.

1. List of Functions

■ Accessory Compatibility List

Category		Product	Remark	ZHBW056A0 [HM051M U43] ZHBW076A0 [HM071M U43] ZHBW096A0 [HM091M U43] ZHBW126A0 [HM121M U33] ZHBW146A0 [HM141M U33] ZHBW166A0 [HM161M U33] ZHBW128A0 [HM123M U33] ZHBW148A0 [HM143M U33] ZHBW168A0 [HM163M U33]
Dry Contact	Simple Contact	PDRYCB000	Simple Dry Contact	O
	Communication Type	PDRYCB400	2 Points Dry Contact (For Setback)	X
		PDRYCB300	8 Points Dry Contact (For Thermostat)	O
		PDRYCB500	Dry Contact for Modbus	X
ETC	Remote temperature sensor	PQRSTA0	-	O
	Zone Controller	ABZCA	-	X
	Electronic thermostat	AQETC	-	X
	CTI (Communication transfer interface)	PKEC0	-	X
	Group control wire	PZCWRCG3	0.25 m	X
	2-Remo Control Wire	PZCWRC2	0.25 m	X
	Extension wire	PZCWRC1	10 m	O
	Wi-Fi controller *	PWFMD200	-	O
	Meter Interface Module	PENKTH000	Interface between IDU and Meter	O
Accessory Kit for AWHP	DHW tank kit (Split)	PHLTA	For Split	X
	DHW tank kit (Monobloc)	PHLTB	For Monobloc	O
	Solar thermal kit	PHLLA	-	O
	Backup heater	HA031M E1 / HA061M E1	-	O
	Drain pan	PHDPB	-	X
Central Controller	AC EZ	PQCSZ250S0	AC EZ	X
	AC Ez Touch	PACEZA000	AC Ez Touch	O
	AC Smart	PACS4B000	AC Smart IV	O
		PACS5A000	AC Smart 5	O
	ACP	PACP4B000	ACP IV	O
		PACP5A000	ACP 5	O
	AC Manager ¹⁾	PACM4B000	AC Manager IV	O
PACM5A000		AC Manager 5	O	
Gateway	IDU PI485	PHNFP14A0	Connected with Indoor Units	X
		PSNFP14A0	Connected with Indoor Units	X
	ODU PI485	PMNFP14A1	PI 485 Gateway	O
	BACnet	PQNFB17C0	ACP BACnet	O
Lonworks	PLNWKB000	ACP Lonworks	O	

Note

1. O: Possible, X: Impossible, - : Not applicable
2. * : Some advanced functions controlled by individual controller cannot be operated.
3. ¹⁾ : ACP, AC Smart, ACP BACnet or ACP Lonworks is needed.
4. If you need more detail, please refer to the **BECON** PDB or the manual of product. (<http://partner.lge.com/global> : Home> Download> Manuals)

2. Specification

■ 1 phase Inverter (5.5 ~ 9 kW)

Nominal Capacity and Nominal Input					ZHBW056A0 [HM051M U43]	ZHBW076A0 [HM071M U43]	ZHBW096A0 [HM091M U43]
-	-	Outdoor Temp. (°C) DB / WB	Leaving Water Temp. (°C)	-			
Capacity	Cooling	35 / 24	18	kW	5.50	7.00	9.00
			7	kW	5.50	7.00	9.00
	Heating	7 / 6	35	kW	5.50	7.00	9.00
			55	kW	5.50	5.50	5.50
		2 / 1	35	kW	3.30	4.20	5.40
Power Input	Cooling	35 / 24	18	kW	1.20	1.56	2.14
			7	kW	1.96	2.59	3.46
	Heating	7 / 6	35	kW	1.22	1.56	2.15
			55	kW	2.04	2.04	2.04
		2 / 1	35	kW	0.94	1.20	1.54
EER	Cooling	35 / 24	18	W/W	4.60	4.50	4.20
			7	W/W	2.80	2.70	2.60
COP	Heating	7 / 6	35	W/W	4.50	4.50	4.18
			55	W/W	2.70	2.70	2.70
			2 / 1	35	W/W	3.52	3.51
SCOP (Low temp. Average)					4.45	4.45	4.45
SCOP (High temp. Average)					3.12	3.12	3.12

Electrical Specifications			ZHBW056A0 [HM051M U43]	ZHBW076A0 [HM071M U43]	ZHBW096A0 [HM091M U43]
Power Supply		V, Ø, Hz	220-240, 1, 50	220-240, 1, 50	220-240, 1, 50
Maximum Running Current	Cooling	A	23.0	23.0	23.0
	Heating	A	23.0	23.0	23.0
Peak Control Running Current	Cooling	A	17.0	17.0	17.0
	Heating	A	17.0	17.0	17.0
Rated Running Current	Cooling	A	5.3	6.9	9.5
	Heating	A	5.4	6.9	9.6
Wiring Connections	Power Supply Cable (included Earth, H07RN-F)	No × mm ²	3 × 4.0	3 × 4.0	3 × 4.0

Technical Specifications				ZHBW056A0 [HM051M U43]	ZHBW076A0 [HM071M U43]	ZHBW096A0 [HM091M U43]
Sound Power Level	Heating	Rated	dB(A)	60	60	60
Dimensions	Unit	W × H × D	mm	1,239 × 907 × 404	1,239 × 907 × 404	1,239 × 907 × 404
	Packed Unit	W × H × D	mm	1,364 × 1,055 × 461	1,364 × 1,055 × 461	1,364 × 1,055 × 461
Weight	Unit		kg	96.0	96.0	96.0
	Packed Unit		kg	109.0	109.0	109.0

Note

1. Due to our policy of innovation some specifications may be changed without notification.
2. Wiring cable size must comply with the applicable local and national codes. And "Electric characteristics" chapter should be considered for electrical work and design. Especially the power cable and circuit breaker should be selected in accordance with that.
3. Sound power level is measured on the rated condition in the reverberation rooms by ISO 3741 standard. Therefore, these values can be increased owing to ambient conditions during operation.
4. Performances are accordance with EN14511.
 - Rated running current : Outdoor Temp. 7°CDB / 6°CWB, LWT 35°C
5. This product contains Fluorinated greenhouse gases.
 - * At least 25A circuit breaker can be used, but when using 3rd party product, connect external power.

2. Specification

Technical Specifications (Water side)				ZHBW056A0 [HM051M U43]	ZHBW076A0 [HM071M U43]	ZHBW096A0 [HM091M U43]
Operation Range (Leaving Water Temp.)	Cooling	Min. ~ Max.	°C DB	5 ~ 27	5 ~ 27	5 ~ 27
	Heating	Min. ~ Max.	°C DB	15 ~ 65	15 ~ 65	15 ~ 65
	DHW *	Min. ~ Max.	°C DB	15 ~ 80	15 ~ 80	15 ~ 80
Water Pump	Type	Canned type for hot water circulation				
	Model	UPM3K 20-75 CHBL				
	Motor Type	BLDC				
	Steps of Pumping Performance	Variable speed 10% to 100%				
	Power input	Min. / Rated	W	6 / 60	6 / 60	6 / 60
	Water Flow Rate	Min. / Rated	ℓ/min	2.3 / 25.9	2.3 / 25.9	2.3 / 25.9
Heat Exchanger	Type	Braze Plate HEX				
	Quantity	1				
	Number of Plate	EA 54				
	Water Volume	ℓ 0.7				
	Water Flow Rate	Min. ~ Max.	ℓ/min	13 ~ 70	13 ~ 70	13 ~ 70
Expansion Vessel	Volume	Max.	ℓ	8	8	8
	Water pressure	Max.	bar	3	3	3
		Pre-charged	bar	1	1	1
Piping Connections	Inlet	mm(inch) Male PT 25(1)				
	Outlet	mm(inch) Male PT 25(1)				
Strainer	Mesh size	28 mesh				
	Material	Stainless Steel				
Relief Valve	Pressure Limit	Upper Limit	bar	3.0	3.0	3.0
	Devices for Water Circuit			-	Relief valve / Flow Switch	
			-	Drain hose / Shut Off Valve		
			-	Pressure gage / Air vent valve		

Technical Specifications (Refrigerant side)				ZHBW056A0 [HM051M U43]	ZHBW076A0 [HM071M U43]	ZHBW096A0 [HM091M U43]
Operation Range (Outdoor Temp.)	Cooling	Min. ~ Max.	°C DB	5 ~ 48	5 ~ 48	5 ~ 48
	Heating	Min. ~ Max.	°C DB	-25 ~ 35	-25 ~ 35	-25 ~ 35
Compressor	Type	Hermetic Sealed Scroll				
	Model	RJB036MAA × 1				
	Motor Type	BLDC				
	Displacement	cm³/Rev. 31.6				
Refrigerant	Type	R32				
	GWP (Global Warming Potential)	675.0				
	Precharged Amount	g 1,400				
	t-CO2 eq.	0.945				
	Control	Electronic Expansion Valve				
Refrigerant Oil	Type	FW68D				
	Charged Volume	cc × No. 1,000				
Fan	Type	Propeller				
	Air Flow Rate	Rated	m³/min × No.	60.0 × 1	60.0 × 1	60.0 × 1
Fan Motor	Type	BLDC				
	Output	W × No. 124 × 1				

Note

- Due to our policy of innovation some specifications may be changed without notification.
- Wiring cable size must comply with the applicable local and national codes. And "Electric characteristics" chapter should be considered for electrical work and design. Especially the power cable and circuit breaker should be selected in accordance with that.
- Sound power level is measured on the rated condition in the reverberation rooms by ISO 3741 standard.
Therefore, these values can be increased owing to ambient conditions during operation.
- Performances are accordance with EN14511.
 - Rated running current : Outdoor Temp. 7°CDB / 6°CWB, LWT 35°C
- This product contains Fluorinated greenhouse gases.
 - * DHW 55~80°C Operating is available only when the booster heater is operating.

2. Specification

■ 1 phase Inverter (12 ~ 16 kW)

Nominal Capacity and Nominal Input					ZHBW126A0 [HM121M U33]	ZHBW146A0 [HM141M U33]	ZHBW166A0 [HM161M U33]	
-	-	Outdoor Temp. (°C) DB / WB	Leaving Water Temp. (°C)	-				
Capacity	Cooling	35 / 24	18	kW	12.00	14.00	16.00	
			7	kW	12.00	14.00	16.00	
	Heating	7 / 6	35	kW	12.00	14.00	16.00	
			55	kW	12.00	12.00	12.00	
		2 / 1	35	kW	11.00	12.00	13.80	
Power Input	Cooling	35 / 24	18	kW	2.61	3.26	4.00	
			7	kW	4.44	5.38	6.40	
	Heating	7 / 6	35	kW	2.61	3.11	3.64	
			55	kW	4.29	4.29	4.29	
			2 / 1	35	kW	3.13	3.42	3.94
	EER	Cooling	35 / 24	18	W/W	4.60	4.30	4.00
7				W/W	2.70	2.60	2.50	
COP	Heating	7 / 6	35	W/W	4.60	4.50	4.40	
			55	W/W	2.80	2.80	2.80	
		2 / 1	35	W/W	3.52	3.51	3.50	
SCOP (Low temp. Average)					4.45	4.45	4.45	
SCOP (High temp. Average)					3.18	3.18	3.18	

Electrical Specifications			ZHBW126A0 [HM121M U33]	ZHBW146A0 [HM141M U33]	ZHBW166A0 [HM161M U33]
Power Supply		V, Ø, Hz	220-240, 1, 50	220-240, 1, 50	220-240, 1, 50
Maximum Running Current	Cooling	A	35.0	35.0	35.0
	Heating	A	35.0	35.0	35.0
Peak Control Running Current	Cooling	A	25.0	25.0	25.0
	Heating	A	27.0	27.0	27.0
Rated Running Current	Cooling	A	11.6	14.4	17.7
	Heating	A	11.6	13.8	16.1
Wiring Connections	Power Supply Cable (included Earth, H07RN-F)	No × mm ²	3 × 6.0	3 × 6.0	3 × 6.0

Technical Specifications				ZHBW126A0 [HM121M U33]	ZHBW146A0 [HM141M U33]	ZHBW166A0 [HM161M U33]
Sound Power Level	Heating	Rated	dB(A)	63	63	63
Dimensions	Unit	W × H × D	mm	1,239 × 1,450 × 390	1,239 × 1,450 × 390	1,239 × 1,450 × 390
	Packed Unit	W × H × D	mm	1,364 × 1,602 × 461	1,364 × 1,602 × 461	1,364 × 1,602 × 461
Weight	Unit		kg	130.0	130.0	130.0
	Packed Unit		kg	145.0	145.0	145.0

Note

1. Due to our policy of innovation some specifications may be changed without notification.
2. Wiring cable size must comply with the applicable local and national codes. And "Electric characteristics" chapter should be considered for electrical work and design. Especially the power cable and circuit breaker should be selected in accordance with that.
3. Sound power level is measured on the rated condition in the reverberation rooms by ISO 3741 standard. Therefore, these values can be increased owing to ambient conditions during operation.
4. Performances are accordance with EN14511.
 - Rated running current : Outdoor Temp. 7°CDB / 6°CWB, LWT 35°C
5. This product contains Fluorinated greenhouse gases.
 - * At least 40A circuit breaker can be used, but when using 3rd party product, connect external power.

2. Specification

Technical Specifications (Water side)				ZHBW126A0 [HM121M U33]	ZHBW146A0 [HM141M U33]	ZHBW166A0 [HM161M U33]
Operation Range (Leaving Water Temp.)	Cooling	Min. ~ Max.	°C DB	5 ~ 27	5 ~ 27	5 ~ 27
	Heating	Min. ~ Max.	°C DB	15 ~ 65	15 ~ 65	15 ~ 65
	DHW *	Min. ~ Max.	°C DB	15 ~ 80	15 ~ 80	15 ~ 80
Water Pump	Type	Canned type for hot water circulation				
	Model	UPML GEO 20-105 CHBL				
	Motor Type	BLDC				
	Steps of Pumping Performance	Variable speed 10% to 100%				
	Power input	Min. / Rated	W	14 / 140	14 / 140	14 / 140
	Water Flow Rate	Min. / Rated	ℓ/min	5.0 / 46.0	5.0 / 46.0	5.0 / 46.0
Heat Exchanger	Type	Brazed Plate HEX				
	Quantity	1				
	Number of Plate	EA 76				
	Water Volume	ℓ 1.0				
	Water Flow Rate	Min. ~ Max.	ℓ/min	13 ~ 70	13 ~ 70	13 ~ 70
Expansion Vessel	Volume	Max.	ℓ	8	8	8
	Water pressure	Max.	bar	3	3	3
		Pre-charged	bar	1	1	1
Piping Connections	Inlet	mm(inch) Male PT 25(1)				
	Outlet	mm(inch) Male PT 25(1)				
Strainer	Mesh size	28 mesh				
	Material	Stainless Steel				
Relief Valve	Pressure Limit	Upper Limit	bar	3.0	3.0	3.0
	Devices for Water Circuit			-	Relief valve / Flow Switch	
			-	Drain hose / Shut Off Valve		
			-	Pressure gage / Air vent valve		

Technical Specifications (Refrigerant side)				ZHBW126A0 [HM121M U33]	ZHBW146A0 [HM141M U33]	ZHBW166A0 [HM161M U33]
Operation Range (Outdoor Temp.)	Cooling	Min. ~ Max.	°C DB	5 ~ 48	5 ~ 48	5 ~ 48
	Heating	Min. ~ Max.	°C DB	-25 ~ 35	-25 ~ 35	-25 ~ 35
Compressor	Type	Hermetic Sealed Scroll				
	Model	RJB036MAA × 1				
	Motor Type	BLDC				
	Displacement	cm³/Rev. 31.6				
Refrigerant	Type	R32				
	GWP (Global Warming Potential)	675.0				
	Precharged Amount	g 2,400				
	t-CO2 eq.	1.620				
	Control	Electronic Expansion Valve				
Refrigerant Oil	Type	FW68D				
	Charged Volume	cc × No. 1,000				
Fan	Type	Propeller				
	Air Flow Rate	Rated	m³/min × No.	60.0 × 2	60.0 × 2	60.0 × 2
Fan Motor	Type	BLDC				
	Output	W × No. 124 × 2				

Note

- Due to our policy of innovation some specifications may be changed without notification.
- Wiring cable size must comply with the applicable local and national codes. And "Electric characteristics" chapter should be considered for electrical work and design. Especially the power cable and circuit breaker should be selected in accordance with that.
- Sound power level is measured on the rated condition in the reverberation rooms by ISO 3741 standard.
Therefore, these values can be increased owing to ambient conditions during operation.
- Performances are accordance with EN14511.
 - Rated running current : Outdoor Temp. 7°CDB / 6°CWB, LWT 35°C
- This product contains Fluorinated greenhouse gases.
 - * DHW 55~80°C Operating is available only when the booster heater is operating.

2. Specification

■ 3 phase Inverter (12 ~ 16 kW)

Nominal Capacity and Nominal Input					ZHBW128A0 [HM123M U33]	ZHBW148A0 [HM143M U33]	ZHBW168A0 [HM163M U33]	
-	-	Outdoor Temp (°C) DB / WB	Leaving Waer Temp (°C)	-				
Capacity	Cooling	35 / 24	18	kW	12.00	14.00	16.00	
			7	kW	12.00	14.00	16.00	
	Heating	7 / 6	35	kW	12.00	14.00	16.00	
			55	kW	12.00	12.00	12.00	
		2 / 1	35	kW	11.00	12.00	13.80	
Power Input	Cooling	35 / 24	18	kW	2.61	3.26	4.00	
			7	kW	4.44	5.38	6.40	
	Heating	7 / 6	35	kW	2.61	3.11	3.64	
			55	kW	4.29	4.29	4.29	
			2 / 1	35	kW	3.13	3.42	3.94
	EER	Cooling	35 / 24	18	W/W	4.60	4.30	4.00
7				W/W	2.70	2.60	2.50	
COP	Heating	7 / 6	35	W/W	4.60	4.50	4.40	
			55	W/W	2.80	2.80	2.80	
		2 / 1	35	W/W	3.52	3.51	3.50	
SCOP (Low temp. Average)					4.45	4.45	4.45	
SCOP (High temp. Average)					3.18	3.18	3.18	

Electrical Specifications			ZHBW128A0 [HM123M U33]	ZHBW148A0 [HM143M U33]	ZHBW168A0 [HM163M U33]
Power Supply		V, Ø, Hz	380-415, 3, 50	380-415, 3, 50	380-415, 3, 50
Maximum Running Current	Cooling	A	15.0	15.0	15.0
	Heating	A	15.0	15.0	15.0
Peak Control Running Current	Cooling	A	10.0	10.0	10.0
	Heating	A	12.0	12.0	12.0
Rated Running Current	Cooling	A	3.8	4.8	5.9
	Heating	A	3.8	4.6	5.4
Wiring Connections	Power Supply Cable (included Earth, H07RN-F)	No × mm ²	5 × 4.0	5 × 4.0	5 × 4.0

Technical Specifications				ZHBW128A0 [HM123M U33]	ZHBW148A0 [HM143M U33]	ZHBW168A0 [HM163M U33]
Sound Power Level	Heating	Rated	dB(A)	63	63	63
Dimensions	Unit	W × H × D	mm	1,239 × 1,450 × 390	1,239 × 1,450 × 390	1,239 × 1,450 × 390
	Packed Unit	W × H × D	mm	1,364 × 1,602 × 461	1,364 × 1,602 × 461	1,364 × 1,602 × 461
Weight	Unit		kg	130.0	130.0	130.0
	Packed Unit		kg	145.0	145.0	145.0

Note

1. Due to our policy of innovation some specifications may be changed without notification.
2. Wiring cable size must comply with the applicable local and national codes. And "Electric characteristics" chapter should be considered for electrical work and design. Especially the power cable and circuit breaker should be selected in accordance with that.
3. Sound power level is measured on the rated condition in the reverberation rooms by ISO 3741 standard. Therefore, these values can be increased owing to ambient conditions during operation.
4. Performances are accordance with EN14511.
 - Rated running current : Outdoor Temp. 7°CDB / 6°CWB, LWT 35°C
5. This product contains Fluorinated greenhouse gases.
 - * At least 20A circuit breaker can be used, but when using 3rd party product, connect external power.

2. Specification

Technical Specifications (Water side)				ZHBW128A0 [HM123M U33]	ZHBW148A0 [HM143M U33]	ZHBW168A0 [HM163M U33]
Operation Range (Leaving Water Temp.)	Cooling	Min. ~ Max.	°C DB	5 ~ 27	5 ~ 27	5 ~ 27
	Heating	Min. ~ Max.	°C DB	15 ~ 65	15 ~ 65	15 ~ 65
	DHW *	Min. ~ Max.	°C DB	15 ~ 80	15 ~ 80	15 ~ 80
Water Pump	Type	Canned type for hot water circulation				
	Model	UPML GEO 20-105 CHBL				
	Motor Type	BLDC				
	Steps of Pumping Performance	Variable speed 10% to 100%				
	Power input	Min. / Rated	W	14 / 140	14 / 140	14 / 140
	Water Flow Rate	Min. / Rated	ℓ/min	5.0 / 46.0	5.0 / 46.0	5.0 / 46.0
Heat Exchanger	Type	Brazed Plate HEX				
	Quantity	1				
	Number of Plate	EA 76				
	Water Volume	ℓ 1.0				
	Water Flow Rate	Min. ~ Max.	ℓ/min	13 ~ 70	13 ~ 70	13 ~ 70
Expansion Vessel	Volume	Max.	ℓ	8	8	8
	Water pressure	Max.	bar	3	3	3
		Pre-charged	bar	1	1	1
Piping Connections	Inlet	mm(inch) Male PT 25(1)				
	Outlet	mm(inch) Male PT 25(1)				
Strainer	Mesh size	28 mesh				
	Material	Stainless Steel				
Relief Valve	Pressure Limit	Upper Limit	bar	3.0	3.0	3.0
	Devices for Water Circuit			-	Relief valve / Flow Switch	
			-	Drain hose / Shut Off Valve		
			-	Pressure gage / Air vent valve		

Technical Specifications (Refrigerant side)				ZHBW128A0 [HM123M U33]	ZHBW148A0 [HM143M U33]	ZHBW168A0 [HM163M U33]
Operation Range (Outdoor Temp.)	Cooling	Min. ~ Max.	°C DB	5 ~ 48	5 ~ 48	5 ~ 48
	Heating	Min. ~ Max.	°C DB	-25 ~ 35	-25 ~ 35	-25 ~ 35
Compressor	Type	Hermetic Sealed Scroll				
	Model	RJB036MAA × 1				
	Motor Type	BLDC				
	Displacement	cm³/Rev. 31.6				
Refrigerant	Type	R32				
	GWP (Global Warming Potential)	675.0				
	Precharged Amount	g 2,400				
	t-CO2 eq.	1.620				
	Control	Electronic Expansion Valve				
Refrigerant Oil	Type	FW68D				
	Charged Volume	cc × No. 1,000				
Fan	Type	Propeller				
	Air Flow Rate	Rated	m³/min × No.	60.0 × 2	60.0 × 2	60.0 × 2
Fan Motor	Type	BLDC				
	Output	W × No. 124 × 2				

Note

- Due to our policy of innovation some specifications may be changed without notification.
- Wiring cable size must comply with the applicable local and national codes. And "Electric characteristics" chapter should be considered for electrical work and design. Especially the power cable and circuit breaker should be selected in accordance with that.
- Sound power level is measured on the rated condition in the reverberation rooms by ISO 3741 standard.
Therefore, these values can be increased owing to ambient conditions during operation.
- Performances are accordance with EN14511.
 - Rated running current : Outdoor Temp. 7°CDB / 6°CWB, LWT 35°C
- This product contains Fluorinated greenhouse gases.
 - * DHW 55~80°C Operating is available only when the booster heater is operating.

2. Specification

■ Backup Heater

Electrical Specification			AHEH036A [HA031M E1]	AHEH066A [HA061M E1]
Backup Heater	Type	-	Sheath	Sheath
	Number of Heating Coil	EA	1	2
	Capacity Combination	kW	3.0	3.0 + 3.0
	Operation	-	Automatic	Automatic
	Heating Steps	Step	1	2
	Power Supply	V, Ø, Hz	220-240, 1, 50	220-240, 1, 50
	Maximum Current	A	12.0	24.0
Wiring Connections	Power Cable (Included Earth, H07RN-F)	No. × mm ²	3 × 1.5	3 × 4.0
	Communication Cable (H07RN-F)	No. × mm ²	4 × 0.75	4 × 0.75

Note

1. Due to our policy of innovation some specifications may be changed without notification.
2. Wiring cable size must comply with the applicable local and national codes. And "Electric characteristics" chapter should be considered for electrical work and design. Especially the power cable and circuit breaker should be selected in accordance with that.

3. Dimensions

Product

◆ ZHBW056A0 [HM051M U43] / ZHBW076A0 [HM071M U43] / ZHBW096A0 [HM091M U43]

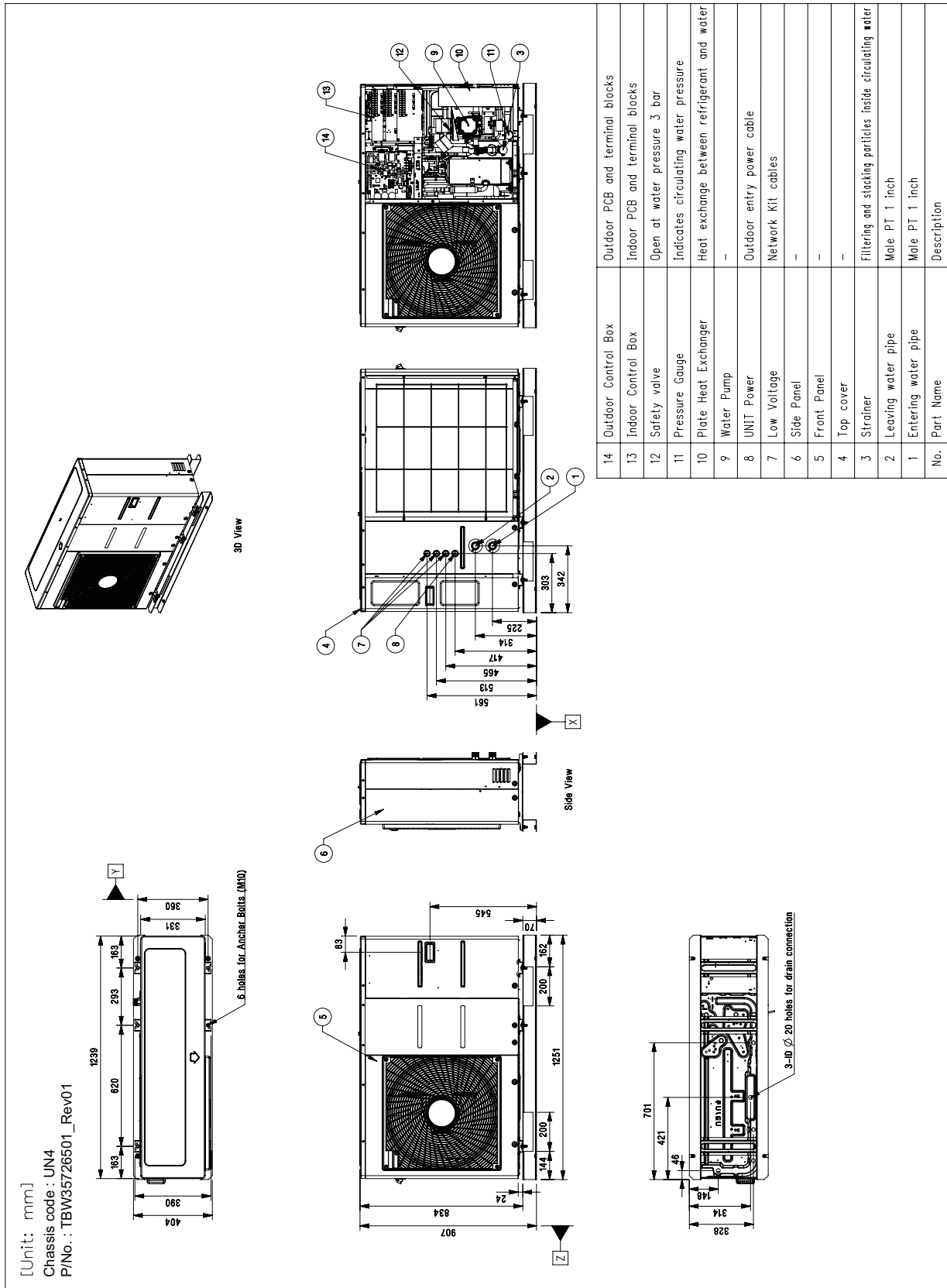

3. Dimensions

- ◆ ZHBW126A0 [HM121M U33] / ZHBW146A0 [HM141M U33] / ZHBW166A0 [HM161M U33]
 ZHBW128A0 [HM123M U33] / ZHBW148A0 [HM143M U33] / ZHBW168A0 [HM163M U33]

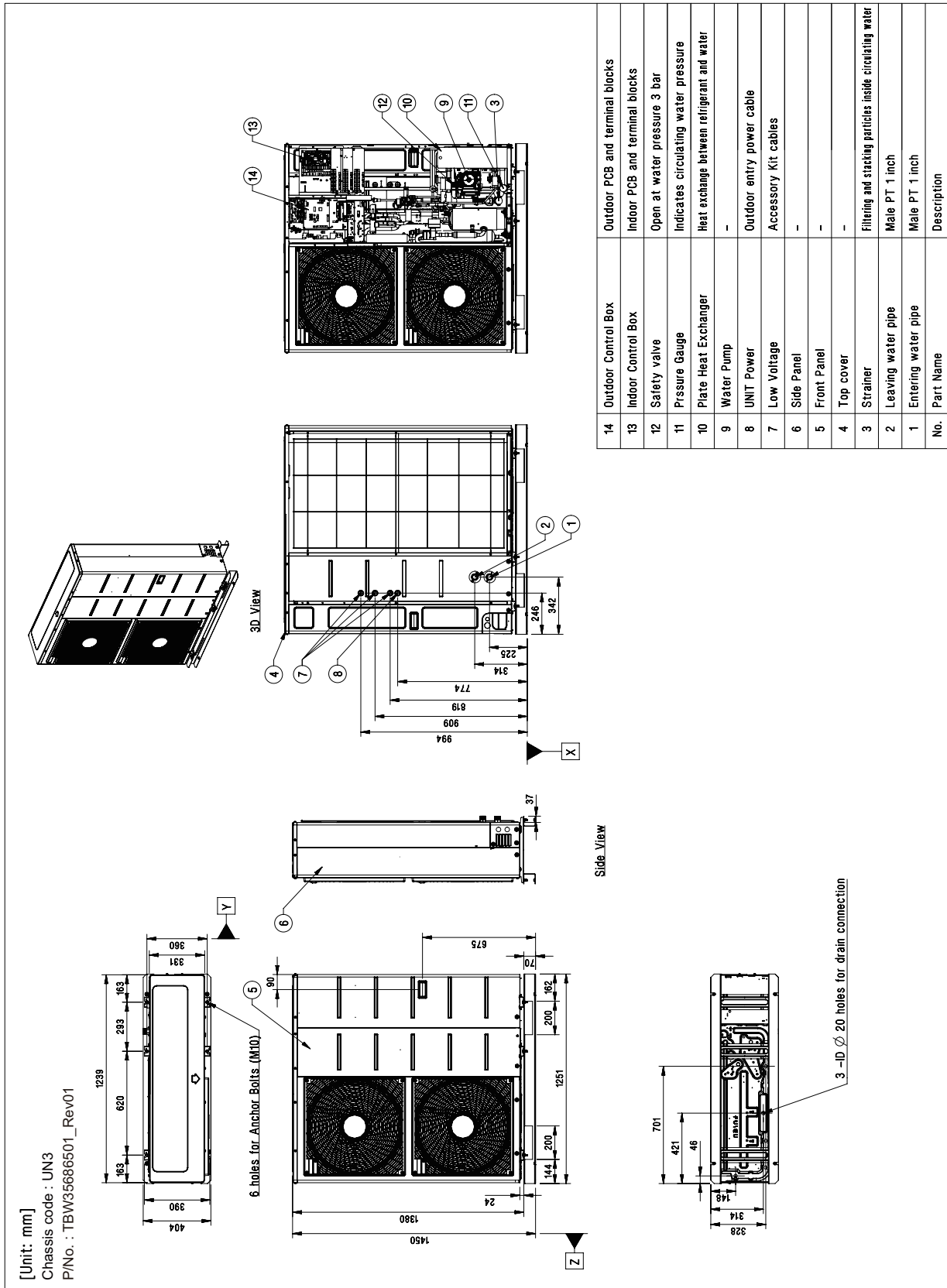

3. Dimensions

Backup Heater

[Unit: mm]
P/No. : TAY37568301

Note
 1. Unit should be installed in compliance with the installation manual in the product box.
 2. Unit should be grounded in accordance with the local regulations or applicable national codes.
 3. All electrical components and materials to be supplied from the site must comply with the local regulations or international codes.

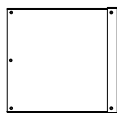
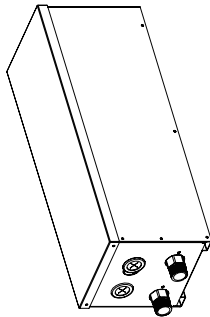

Side View

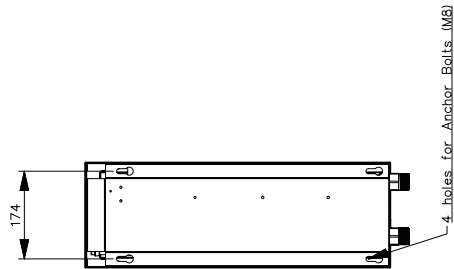

Side View

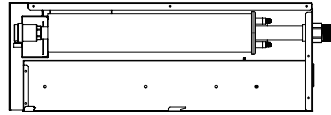
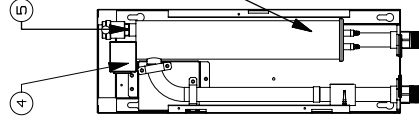
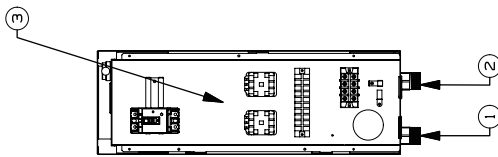
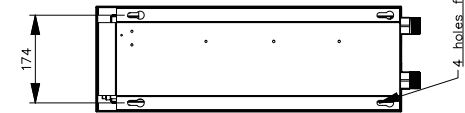
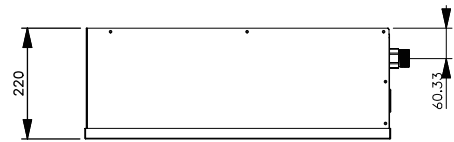

Side View

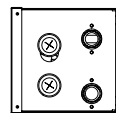

6	Electric Heater	refer the related information
5	Air vent	Air purging when charging water
4	Thermal switch	Out-off power input to E/Heater at 90°C
3	Control Box	Circuit Breaker, Magnetic Switch, Terminal Blocks
2	Entering Water Pipe	Male PT 1 inch
1	Leaving Water Pipe	Male PT 1 inch
No.	Part Name	Description

4. Piping Diagram

- ◆ ZHBW126A0 [HM121M U33] / ZHBW146A0 [HM141M U33] / ZHBW166A0 [HM161M U33]
 ZHBW128A0 [HM123M U33] / ZHBW148A0 [HM143M U33] / ZHBW168A0 [HM163M U33]

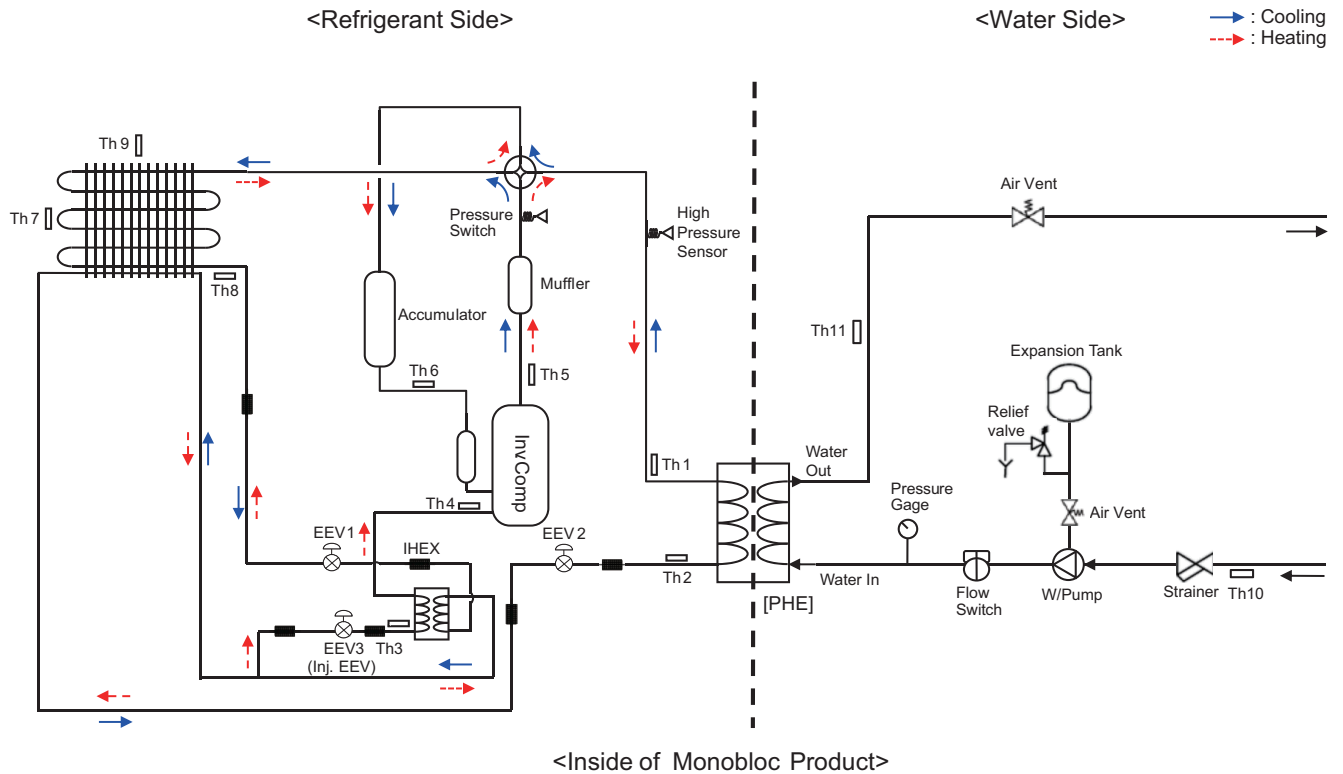

Category	Symbol	Meaning	PCB Connector
Refrigerant side	Th1	Outlet evaporator temperature sensor	CN_PIPE/OUT
	Th2	Inlet evaporator temperature sensor	CN_PIPE/IN
	Th3	Inlet IHEX temperature sensor	CN_VI_IN
	Th4	Outlet IHEX temperature sensor	CN_VI_OUT
	Th5	Compressor-discharge pipe temperature sensor	CN_DISCHA
	Th6	Compressor-suction pipe temperature sensor	CN_SUCTION
	Th7	Condenser middle temperature sensor	CN_MID
	Th8	Condenser temperature sensor	CN_C_PIPE
	Th9	Outdoor air temperature sensor	CN_AIR
	EEV1	Electronic Expansion Valve (Heating)	CN_EEV1_WH
EEV2	Electronic Expansion Valve (Cooling)	CN_EEV2_BL	
EEV3	Electronic Expansion Valve (Injection)	CN_EEV_MAIN_VI	
Water Side	Th 10	Entering water temperature sensor	CN_TH3
	Th 11	Leaving water temperature sensor	

5. Wiring Diagram

◆ ZHBW056A0 [HM051M U43] / ZHBW076A0 [HM071M U43] / ZHBW096A0 [HM091M U43]

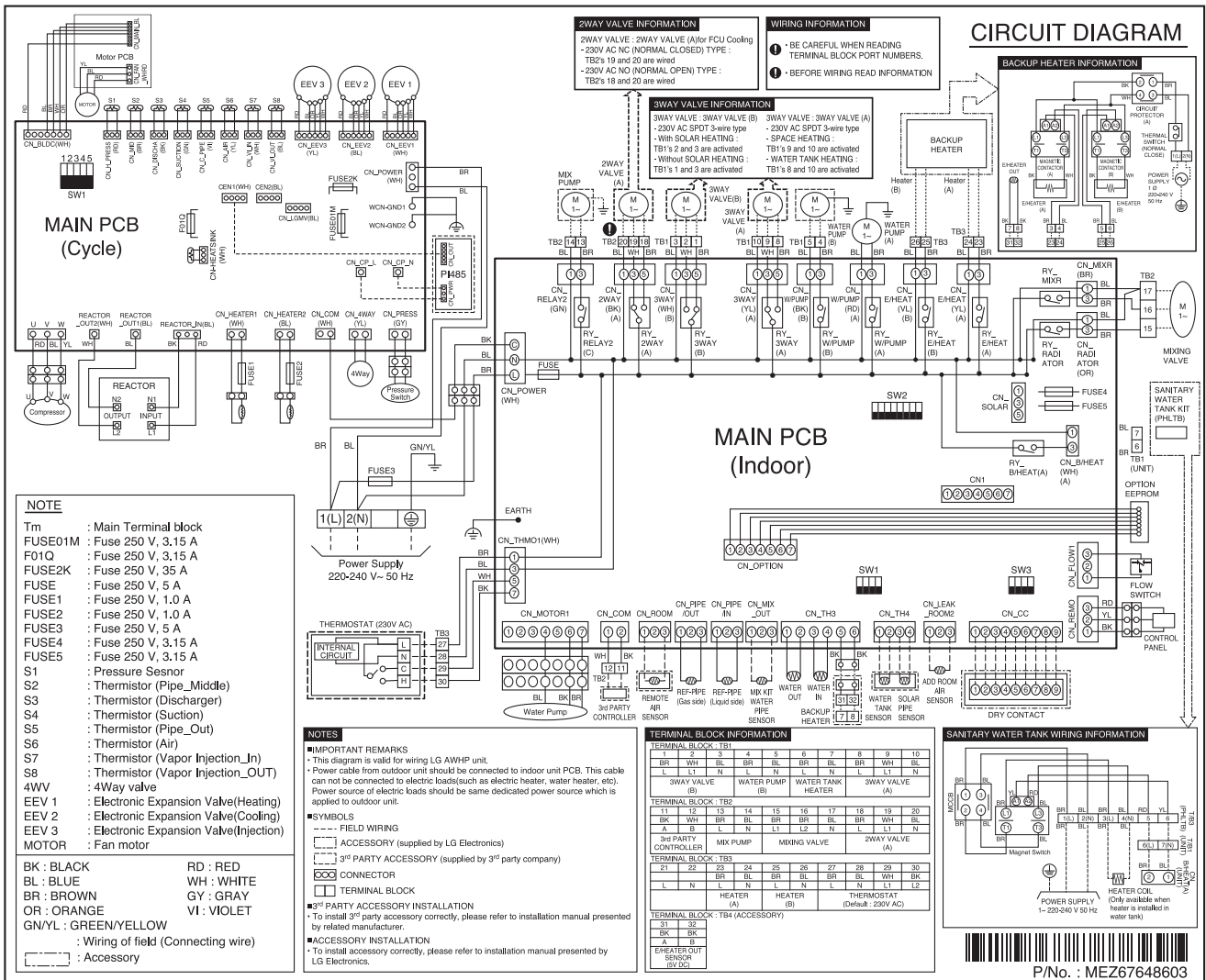

5. Wiring Diagram

◆ ZHBW128A0 [HM123M U33] / ZHBW148A0 [HM143M U33] / ZHBW168A0 [HM163M U33]

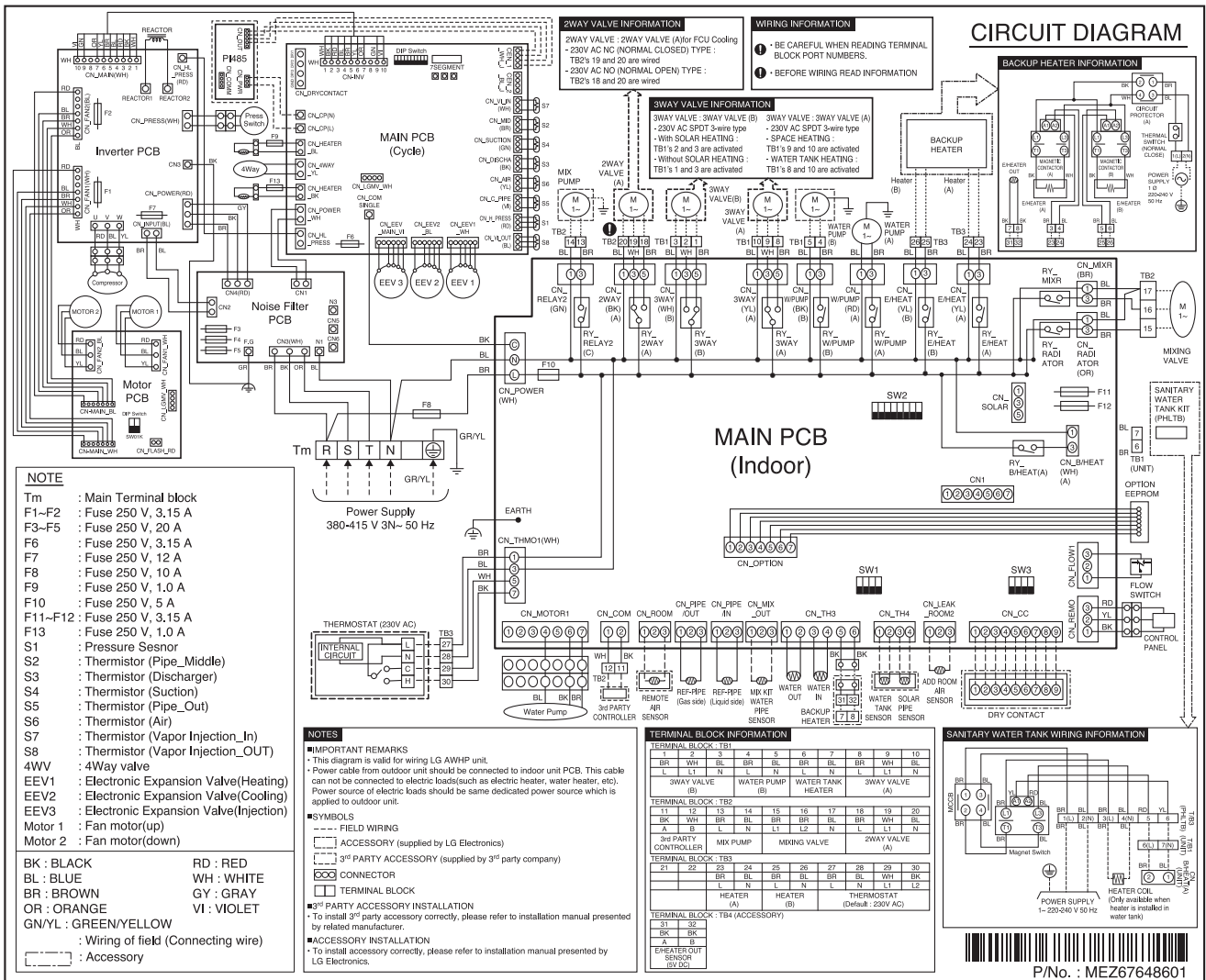

6. Performance Data

6.1 Cooling Operation

■ Maximum Cooling Capacity

◆ ZHBW056A0 [HM051M U43]

Outdoor Temperature [°C DB]	Water flow rate 15.8 LPM													
	LWT 7 °C		LWT 10 °C		LWT 13 °C		LWT 15 °C		LWT 18 °C		LWT 20 °C		LWT 22 °C	
	TC	COP	TC	COP	TC	COP	TC	COP	TC	COP	TC	COP	TC	COP
10	5.16	4.43	5.65	4.86	6.14	5.29	6.47	5.58	6.96	6.01	7.29	6.30	7.62	6.59
20	5.29	3.78	5.59	4.23	5.89	4.69	6.08	4.99	6.38	5.45	6.58	5.75	6.77	6.05
30	5.43	3.13	5.53	3.60	5.63	4.08	5.69	4.40	5.79	4.88	5.86	5.20	5.92	5.52
35	5.50	2.80	5.50	3.29	5.50	3.78	5.50	4.11	5.50	4.60	5.50	4.93	5.50	5.25
40	5.57	2.47	5.50	2.95	5.43	3.42	5.38	3.74	5.31	4.21	5.27	4.52	5.22	4.84
45	5.64	2.15	5.50	2.60	5.36	3.06	5.27	3.36	5.13	3.82	5.04	4.12	4.94	4.42

◆ ZHBW076A0 [HM071M U43]

Outdoor Temperature [°C DB]	Water flow rate 20.1 LPM													
	LWT 7 °C		LWT 10 °C		LWT 13 °C		LWT 15 °C		LWT 18 °C		LWT 20 °C		LWT 22 °C	
	TC	COP	TC	COP	TC	COP	TC	COP	TC	COP	TC	COP	TC	COP
10	6.56	4.33	7.19	4.75	7.82	5.18	8.24	5.46	8.86	5.88	9.28	6.16	9.70	6.44
20	6.74	3.68	7.11	4.13	7.49	4.58	7.74	4.88	8.12	5.33	8.37	5.63	8.62	5.93
30	6.91	3.03	7.04	3.50	7.16	3.98	7.25	4.30	7.37	4.78	7.46	5.09	7.54	5.41
35	7.00	2.70	7.00	3.19	7.00	3.68	7.00	4.01	7.00	4.50	7.00	4.83	7.00	5.15
40	7.09	2.37	7.00	2.85	6.91	3.32	6.85	3.63	6.76	4.10	6.70	4.42	6.65	4.73
45	7.18	2.05	7.00	2.50	6.82	2.95	6.70	3.25	6.53	3.70	6.41	4.01	6.29	4.31

◆ ZHBW096A0 [HM091M U43]

Outdoor Temperature [°C DB]	Water flow rate 25.9 LPM													
	LWT 7 °C		LWT 10 °C		LWT 13 °C		LWT 15 °C		LWT 18 °C		LWT 20 °C		LWT 22 °C	
	TC	COP	TC	COP	TC	COP	TC	COP	TC	COP	TC	COP	TC	COP
10	8.44	4.04	9.24	4.44	10.05	4.83	10.59	5.09	11.40	5.49	11.93	5.75	12.47	6.01
20	8.66	3.47	9.15	3.88	9.63	4.29	9.95	4.56	10.44	4.97	10.76	5.25	11.08	5.52
30	8.89	2.89	9.05	3.32	9.21	3.74	9.32	4.03	9.48	4.46	9.59	4.74	9.69	5.03
35	9.00	2.60	9.00	3.04	9.00	3.47	9.00	3.76	9.00	4.20	9.00	4.49	9.00	4.78
40	9.11	2.31	9.00	2.73	8.89	3.16	8.81	3.44	8.70	3.86	8.62	4.14	8.54	4.42
45	9.23	2.02	9.00	2.43	8.77	2.84	8.62	3.11	8.39	3.52	8.24	3.79	8.09	4.06

Note

1. DB : Dry bulb temperature(°C), LWT : Leaving water temperature(°C), LPM : Liters per minute (ℓ/min)
2. TC : Total capacity(kW), COP : Coefficient of performance (kW/kW)
3. Direct interpolation is permissible. Do not extrapolate.
4. Measuring procedure follows EN-14511.
 - Rated values are based on standard conditions, and it can be found on specifications.
 - Above table values may not be matched according to installation condition. Except for rated value, the performance is not guaranteed.
 - In accordance with the test standard(or nations), the rating will vary slightly.

6. Performance Data

◆ ZHBW126A0 [HM121M U33] / ZHBW128A0 [HM123M U33]

Outdoor Temperature [°C DB]	Water flow rate 34.5 LPM													
	LWT 7 °C		LWT 10 °C		LWT 13 °C		LWT 15 °C		LWT 18 °C		LWT 20 °C		LWT 22 °C	
	TC	COP	TC	COP	TC	COP	TC	COP	TC	COP	TC	COP	TC	COP
10	11.25	4.43	12.33	4.86	13.40	5.29	14.12	5.58	15.20	6.01	15.91	6.30	16.63	6.59
20	11.55	3.74	12.20	4.20	12.84	4.67	13.27	4.98	13.92	5.45	14.35	5.76	14.78	6.07
30	11.85	3.05	12.07	3.55	12.28	4.05	12.42	4.38	12.64	4.88	12.78	5.22	12.93	5.55
35	12.00	2.70	12.00	3.22	12.00	3.74	12.00	4.08	12.00	4.60	12.00	4.95	12.00	5.29
40	12.15	2.35	12.00	2.85	11.85	3.35	11.75	3.68	11.59	4.17	11.49	4.50	11.39	4.83
45	12.30	2.01	12.00	2.48	11.69	2.95	11.49	3.27	11.19	3.74	10.99	4.06	10.78	4.37

◆ ZHBW146A0 [HM141M U33] / ZHBW148A0 [HM143M U33]

Outdoor Temperature [°C DB]	Water flow rate 40.3 LPM													
	LWT 7 °C		LWT 10 °C		LWT 13 °C		LWT 15 °C		LWT 18 °C		LWT 20 °C		LWT 22 °C	
	TC	COP	TC	COP	TC	COP	TC	COP	TC	COP	TC	COP	TC	COP
10	13.13	4.14	14.38	4.54	15.64	4.95	16.47	5.22	17.73	5.62	18.57	5.89	19.40	6.16
20	13.48	3.52	14.23	3.95	14.98	4.38	15.48	4.66	16.24	5.09	16.74	5.38	17.24	5.66
30	13.83	2.91	14.08	3.36	14.33	3.81	14.49	4.11	14.75	4.56	14.91	4.87	15.08	5.17
35	14.00	2.60	14.00	3.06	14.00	3.53	14.00	3.84	14.00	4.30	14.00	4.61	14.00	4.92
40	14.18	2.29	14.00	2.74	13.82	3.18	13.70	3.48	13.53	3.93	13.41	4.22	13.29	4.52
45	14.35	1.98	14.00	2.41	13.64	2.84	13.41	3.13	13.05	3.55	12.82	3.84	12.58	4.13

◆ ZHBW166A0 [HM161M U33] / ZHBW168A0 [HM163M U33]

Outdoor Temperature [°C DB]	Water flow rate 46.0 LPM													
	LWT 7 °C		LWT 10 °C		LWT 13 °C		LWT 15 °C		LWT 18 °C		LWT 20 °C		LWT 22 °C	
	TC	COP	TC	COP	TC	COP	TC	COP	TC	COP	TC	COP	TC	COP
10	15.00	3.85	16.43	4.23	17.87	4.60	18.83	4.85	20.26	5.23	21.22	5.48	22.17	5.73
20	15.40	3.31	16.26	3.70	17.12	4.09	17.70	4.35	18.56	4.74	19.13	5.00	19.70	5.26
30	15.80	2.77	16.09	3.17	16.37	3.57	16.57	3.84	16.85	4.25	17.04	4.51	17.23	4.78
35	16.00	2.50	16.00	2.91	16.00	3.32	16.00	3.59	16.00	4.00	16.00	4.27	16.00	4.55
40	16.20	2.23	16.00	2.63	15.80	3.02	15.66	3.29	15.46	3.68	15.32	3.95	15.19	4.21
45	16.40	1.96	16.00	2.34	15.59	2.73	15.32	2.98	14.92	3.37	14.65	3.62	14.38	3.88

Note

1. DB : Dry bulb temperature(°C), LWT : Leaving water temperature(°C), LPM : Liters per minute (ℓ/min)
2. TC : Total capacity(kW), COP : Coefficient of performance (kW/kW)
3. Direct interpolation is permissible. Do not extrapolate.
4. Measuring procedure follows EN-14511.
 - Rated values are based on standard conditions, and it can be found on specifications.
 - Above table values may not be matched according to installation condition. Except for rated value, the performance is not guaranteed.
 - In accordance with the test standard(or nations), the rating will vary slightly.

6. Performance Data

6.2 Heating Operation

■ Maximum Heating Capacity (Include defrost effect)

◆ ZHBW056A0 [HM051M U43]

Outdoor Temperature [°C DB]	Water flow rate 34.5 LPM								Water flow rate 21.6 LPM				Water flow rate 17.3 LPM			
	LWT 30 °C		LWT 35 °C		LWT 40 °C		LWT 45 °C		LWT 50 °C		LWT 55 °C		LWT 60 °C		LWT 65 °C	
	TC	COP	TC	COP	TC	COP	TC	COP	TC	COP	TC	COP	TC	COP	TC	COP
-25	3.79	1.88	3.67	1.75	3.54	1.63	3.42	1.50	-	-	-	-	-	-	-	-
-20	4.22	2.51	4.09	2.01	3.96	1.86	3.83	1.72	3.70	1.57	-	-	-	-	-	-
-15	4.66	2.42	4.52	2.27	4.38	2.10	4.25	1.93	4.11	1.77	3.97	1.60	-	-	-	-
-7	5.50	3.18	5.50	2.99	5.50	2.79	5.50	2.60	5.50	2.41	5.50	2.21	5.50	2.02	-	-
-4	5.50	3.36	5.50	3.14	5.50	2.93	5.50	2.71	5.50	2.49	5.50	2.28	5.50	2.06	5.50	1.91
-2	5.50	3.51	5.50	3.25	5.50	3.04	5.50	2.83	5.50	2.63	5.50	2.42	5.50	2.21	5.50	2.01
2	5.50	3.52	5.50	3.45	5.50	3.25	5.50	3.04	5.50	2.83	5.50	2.63	5.50	2.42	5.50	2.21
7	5.50	4.84	5.50	4.50	5.50	4.16	5.50	3.82	5.50	3.49	5.50	3.15	5.50	2.81	5.50	2.47
10	5.50	5.14	5.50	4.78	5.50	4.42	5.50	4.06	5.50	3.70	5.50	3.35	5.50	2.99	5.50	2.63
15	5.50	6.12	5.50	5.66	5.50	5.20	5.50	4.73	5.50	4.27	5.50	3.81	5.50	3.35	5.50	2.88
18	5.50	6.45	5.50	5.96	5.50	5.48	5.50	4.99	5.50	4.50	5.50	4.01	5.50	3.53	5.50	3.04
20	5.50	6.67	5.50	6.17	5.50	5.66	5.50	5.16	5.50	4.65	5.50	4.15	5.50	3.65	5.50	3.14
35	5.50	8.31	5.50	7.68	5.50	7.05	5.50	6.43	5.50	5.80	5.50	5.17	5.50	4.54	5.50	3.91

◆ ZHBW076A0 [HM071M U43]

Outdoor Temperature [°C DB]	Water flow rate 40.3 LPM								Water flow rate 25.2 LPM				Water flow rate 20.1 LPM			
	LWT 30 °C		LWT 35 °C		LWT 40 °C		LWT 45 °C		LWT 50 °C		LWT 55 °C		LWT 60 °C		LWT 65 °C	
	TC	COP	TC	COP	TC	COP	TC	COP	TC	COP	TC	COP	TC	COP	TC	COP
-25	4.82	1.99	4.67	1.73	4.51	1.48	4.36	1.22	-	-	-	-	-	-	-	-
-20	5.38	2.47	5.21	1.98	5.05	1.77	4.88	1.56	4.72	1.35	-	-	-	-	-	-
-15	5.93	2.38	5.76	2.22	5.58	2.06	5.41	1.90	5.23	1.74	5.06	1.58	-	-	-	-
-7	7.00	3.15	7.00	2.96	7.00	2.77	7.00	2.58	7.00	2.38	7.00	2.19	7.00	2.00	-	-
-4	7.00	3.33	7.00	3.11	7.00	2.90	7.00	2.68	7.00	2.47	7.00	2.25	7.00	2.04	7.00	1.89
-2	7.00	3.51	7.00	3.21	7.00	3.01	7.00	2.81	7.00	2.60	7.00	2.40	7.00	2.19	7.00	1.99
2	7.00	3.52	7.00	3.42	7.00	3.21	7.00	3.01	7.00	2.81	7.00	2.60	7.00	2.40	7.00	2.19
7	7.00	4.69	7.00	4.50	7.00	4.16	7.00	3.82	7.00	3.47	7.00	3.13	7.00	2.79	7.00	2.45
10	7.00	5.14	7.00	4.78	7.00	4.42	7.00	4.05	7.00	3.69	7.00	3.33	7.00	2.96	7.00	2.60
15	7.00	6.02	7.00	5.57	7.00	5.12	7.00	4.67	7.00	4.21	7.00	3.76	7.00	3.31	7.00	2.86
18	7.00	6.34	7.00	5.87	7.00	5.39	7.00	4.92	7.00	4.44	7.00	3.96	7.00	3.49	7.00	3.01
20	7.00	6.56	7.00	6.07	7.00	5.57	7.00	5.08	7.00	4.59	7.00	4.10	7.00	3.60	7.00	3.11
35	7.00	8.17	7.00	7.56	7.00	6.95	7.00	6.33	7.00	5.72	7.00	5.10	7.00	4.49	7.00	3.88

◆ ZHBW096A0 [HM091M U43]

Outdoor Temperature [°C DB]	Water flow rate 46.0 LPM								Water flow rate 28.8 LPM				Water flow rate 23.0 LPM			
	LWT 30 °C		LWT 35 °C		LWT 40 °C		LWT 45 °C		LWT 50 °C		LWT 55 °C		LWT 60 °C		LWT 65 °C	
	TC	COP	TC	COP	TC	COP	TC	COP	TC	COP	TC	COP	TC	COP	TC	COP
-25	6.20	1.95	6.00	1.70	5.80	1.45	5.60	1.20	-	-	-	-	-	-	-	-
-20	6.91	2.45	6.70	1.96	6.49	1.75	6.28	1.54	6.06	1.33	-	-	-	-	-	-
-15	7.63	2.39	7.40	2.22	7.18	2.05	6.95	1.89	6.73	1.72	6.50	1.55	-	-	-	-
-7	9.00	3.09	9.00	2.90	9.00	2.71	9.00	2.53	9.00	2.34	9.00	2.15	9.00	1.96	-	-
-4	9.00	3.26	9.00	3.05	9.00	2.84	9.00	2.63	9.00	2.42	9.00	2.21	9.00	2.00	9.00	1.85
-2	9.00	3.51	9.00	3.15	9.00	2.95	9.00	2.75	9.00	2.55	9.00	2.35	9.00	2.15	9.00	1.95
2	9.00	3.52	9.00	3.35	9.00	3.15	9.00	2.95	9.00	2.75	9.00	2.55	9.00	2.35	9.00	2.15
7	9.00	4.70	9.00	4.18	9.00	3.88	9.00	3.59	9.00	3.29	9.00	2.99	9.00	2.70	9.00	2.40
10	9.00	4.76	9.00	4.44	9.00	4.13	9.00	3.81	9.00	3.50	9.00	3.18	9.00	2.87	9.00	2.55
15	9.00	6.07	9.00	5.60	9.00	5.13	9.00	4.67	9.00	4.20	9.00	3.73	9.00	3.27	9.00	2.80
18	9.00	6.39	9.00	5.90	9.00	5.41	9.00	4.92	9.00	4.43	9.00	3.93	9.00	3.44	9.00	2.95
20	9.00	6.61	9.00	6.10	9.00	5.59	9.00	5.08	9.00	4.58	9.00	4.07	9.00	3.56	9.00	3.05
35	9.00	8.23	9.00	7.60	9.00	6.97	9.00	6.33	9.00	5.70	9.00	5.07	9.00	4.43	9.00	3.80

Note

1. DB : Dry bulb temperature(°C), LWT : Leaving water temperature(°C), LPM : Liters per minute (ℓ/min)
2. TC : Total capacity(kW), COP : Coefficient of performance (kW/kW)
3. Direct interpolation is permissible. Do not extrapolate.
4. Measuring procedure follows EN-14511.
 - Rated values are based on standard conditions, and it can be found on specifications.
 - Above table values may not be matched according to installation condition. Except for rated value, the performance is not guaranteed.
 - In accordance with the test standard(or nations), the rating will vary slightly.
5. The shaded areas are the operative areas.

6. Performance Data

◆ ZHBW126A0 [HM121M U33] / ZHBW128A0 [HM123M U33]

Outdoor Temperature [°C DB]	Water flow rate 34.5 LPM								Water flow rate 21.6 LPM				Water flow rate 17.3 LPM			
	LWT 30 °C		LWT 35 °C		LWT 40 °C		LWT 45 °C		LWT 50 °C		LWT 55 °C		LWT 60 °C		LWT 65 °C	
	TC	COP	TC	COP	TC	COP	TC	COP	TC	COP	TC	COP	TC	COP	TC	COP
-25	8.75	2.13	8.50	1.85	8.25	1.58	8.00	1.30	-	-	-	-	-	-	-	-
-20	10.13	2.34	10.00	2.13	9.88	1.91	9.75	1.70	9.63	1.49	-	-	-	-	-	-
-15	11.50	2.55	11.50	2.40	11.50	2.25	11.50	2.10	11.50	1.95	11.50	1.80	-	-	-	-
-7	12.00	3.15	12.00	3.00	12.00	2.85	12.00	2.70	12.00	2.55	12.00	2.40	12.00	2.25	-	-
-4	12.00	3.36	12.00	3.17	12.00	2.97	12.00	2.78	12.00	2.59	12.00	2.39	12.00	2.20	12.00	2.05
-2	12.00	3.47	12.00	3.28	12.00	3.09	12.00	2.90	12.00	2.71	12.00	2.53	12.00	2.34	12.00	2.15
2	12.00	3.69	12.00	3.50	12.00	3.31	12.00	3.12	12.00	2.93	12.00	2.73	12.00	2.54	12.00	2.35
7	12.00	4.93	12.00	4.60	12.00	4.27	12.00	3.93	12.00	3.60	12.00	2.80	12.00	2.60	12.00	2.60
10	12.00	5.22	12.00	4.87	12.00	4.51	12.00	4.16	12.00	3.81	12.00	3.46	12.00	3.10	12.00	2.75
15	12.00	5.99	12.00	5.56	12.00	5.13	12.00	4.71	12.00	4.28	12.00	3.85	12.00	3.43	12.00	3.00
18	12.00	6.29	12.00	5.84	12.00	5.39	12.00	4.94	12.00	4.49	12.00	4.05	12.00	3.60	12.00	3.15
20	12.00	6.49	12.00	6.02	12.00	5.56	12.00	5.10	12.00	4.64	12.00	4.17	12.00	3.71	12.00	3.25
35	12.00	7.98	12.00	7.41	12.00	6.84	12.00	6.28	12.00	5.71	12.00	5.14	12.00	4.57	12.00	4.00

◆ ZHBW146A0 [HM141M U33] / ZHBW148A0 [HM143M U33]

Outdoor Temperature [°C DB]	Water flow rate 40.3 LPM								Water flow rate 25.2 LPM				Water flow rate 20.1 LPM			
	LWT 30 °C		LWT 35 °C		LWT 40 °C		LWT 45 °C		LWT 50 °C		LWT 55 °C		LWT 60 °C		LWT 65 °C	
	TC	COP	TC	COP	TC	COP	TC	COP	TC	COP	TC	COP	TC	COP	TC	COP
-25	9.25	2.08	9.00	1.80	8.75	1.53	8.50	1.25	-	-	-	-	-	-	-	-
-20	10.63	2.26	10.50	2.05	10.38	1.84	10.25	1.63	10.13	1.41	-	-	-	-	-	-
-15	12.00	2.45	12.00	2.30	12.00	2.15	12.00	2.00	12.00	1.85	12.00	1.70	-	-	-	-
-7	14.00	3.12	14.00	2.95	14.00	2.79	14.00	2.63	14.00	2.46	14.00	2.30	14.00	2.14	-	-
-4	14.00	3.30	14.00	3.10	14.00	2.90	14.00	2.70	14.00	2.50	14.00	2.30	14.00	2.10	14.00	1.95
-2	14.00	3.39	14.00	3.20	14.00	3.01	14.00	2.82	14.00	2.63	14.00	2.43	14.00	2.24	14.00	2.05
2	14.00	3.65	14.00	3.40	14.00	3.21	14.00	3.02	14.00	2.83	14.00	2.63	14.00	2.44	14.00	2.25
7	14.00	4.83	14.00	4.50	14.00	4.17	14.00	3.83	14.00	3.50	14.00	2.78	14.00	2.50	14.00	2.50
10	14.00	5.12	14.00	4.77	14.00	4.42	14.00	4.06	14.00	3.71	14.00	3.36	14.00	3.00	14.00	2.65
15	14.00	6.02	14.00	5.57	14.00	5.13	14.00	4.68	14.00	4.24	14.00	3.79	14.00	3.35	14.00	2.90
18	14.00	6.33	14.00	5.86	14.00	5.39	14.00	4.92	14.00	4.45	14.00	3.99	14.00	3.52	14.00	3.05
20	14.00	6.53	14.00	6.05	14.00	5.57	14.00	5.08	14.00	4.60	14.00	4.12	14.00	3.63	14.00	3.15
35	14.00	8.09	14.00	7.49	14.00	6.89	14.00	6.29	14.00	5.70	14.00	5.10	14.00	4.50	14.00	3.90

◆ ZHBW166A0 [HM161M U33] / ZHBW168A0 [HM163M U33]

Outdoor Temperature [°C DB]	Water flow rate 46.0 LPM								Water flow rate 28.8 LPM				Water flow rate 23.0 LPM			
	LWT 30 °C		LWT 35 °C		LWT 40 °C		LWT 45 °C		LWT 50 °C		LWT 55 °C		LWT 60 °C		LWT 65 °C	
	TC	COP	TC	COP	TC	COP	TC	COP	TC	COP	TC	COP	TC	COP	TC	COP
-25	10.50	1.96	10.00	1.70	9.50	1.44	9.00	1.18	-	-	-	-	-	-	-	-
-20	12.30	2.33	11.75	1.94	11.44	1.74	11.13	1.55	10.75	1.34	-	-	-	-	-	-
-15	14.10	2.70	13.50	2.18	13.38	2.05	13.25	1.92	13.13	1.78	13.00	1.65	-	-	-	-
-7	16.00	2.96	16.00	2.80	16.00	2.64	16.00	2.48	16.00	2.31	16.00	2.15	16.00	1.99	-	-
-4	16.00	3.18	16.00	2.98	16.00	2.79	16.00	2.59	16.00	2.40	16.00	2.20	16.00	2.01	16.00	1.79
-2	16.00	3.51	16.00	3.11	16.00	2.90	16.00	2.70	16.00	2.50	16.00	2.30	16.00	2.10	16.00	1.90
2	16.00	3.52	16.00	3.35	16.00	3.14	16.00	2.93	16.00	2.73	16.00	2.52	16.00	2.31	16.00	2.10
7	16.00	4.74	16.00	4.40	16.00	4.06	16.00	3.72	16.00	3.38	16.00	2.75	16.00	2.40	16.00	2.36
10	16.00	5.05	16.00	4.69	16.00	4.33	16.00	3.96	16.00	3.60	16.00	3.24	16.00	2.88	16.00	2.51
15	16.00	5.67	16.00	5.54	16.00	5.08	16.00	4.62	16.00	4.16	16.00	3.69	16.00	3.23	16.00	2.77
18	16.00	6.34	16.00	5.85	16.00	5.36	16.00	4.87	16.00	4.39	16.00	3.90	16.00	3.41	16.00	2.93
20	16.00	6.56	16.00	6.05	16.00	5.55	16.00	5.05	16.00	4.54	16.00	4.04	16.00	3.53	16.00	3.03
35	16.00	8.23	16.00	7.60	16.00	6.96	16.00	6.33	16.00	5.70	16.00	5.07	16.00	4.43	16.00	3.80

Note

1. DB : Dry bulb temperature(°C), LWT : Leaving water temperature(°C), LPM : Liters per minute (l/min)
2. TC : Total capacity(kW), COP : Coefficient of performance (kW/kW)
3. Direct interpolation is permissible. Do not extrapolate.
4. Measuring procedure follows EN-14511.
 - Rated values are based on standard conditions, and it can be found on specifications.
 - Above table values may not be matched according to installation condition. Except for rated value, the performance is not guaranteed.
 - In accordance with the test standard(or nations), the rating will vary slightly.
5. The shaded areas are the operative areas.

7. Electric Characteristics

■ Wiring of Main Power Supply and Equipment Capacity

1. Bear in mind ambient conditions (ambient temperature, direct sunlight, rain liquid, etc.) when proceeding with the wiring and connections
 2. The wire size is the minimum value for metal conduit wiring. The power cord size should be 1 rank thicker taking into account the line voltage drops. Make sure the power-supply voltage does not drop more than 10%.
 3. Specific wiring requirements should adhere to the wiring regulations of the region.
 4. Power supply cords of parts of appliances for outdoor use should not be lighter than polychloroprene sheathed flexible cord.
 5. Don't install an individual switch or electrical outlet to disconnect each of indoor unit separately from the power supply.
-

WARNING

- Follow ordinance of your governmental organization for technical standard related to electrical equipment, wiring regulations and guidance of each electric power company.
 - Make sure to use specified wires for connections so that no external force is imparted to terminal connections. If connections are not fixed firmly, it may cause heating or fire.
 - Make sure to use the appropriate type of overcurrent protection switch. Note that generated overcurrent may include some amount of direct current.
-

CAUTION

- Some installation site may require attachment of an earth leakage breaker. If no earth leakage breaker is installed, it may cause an electric shock.
 - Do not use anything other than breaker and fuse with correct capacity. Using fuse and wire or copper wire with too large capacity may cause a malfunction of unit or fire.
-

7. Electric Characteristics

Outdoor Unit	Phase / Volts / Hz	Voltage range	Power Supply for Heater	
			DHW Tank Heater	
			Capacity (kW)	Power Supply
ZHBW056A0 [HM051M U43]	1 Ø / 220-240 V / 50 Hz	Min. : 198 Max. : 264	3	1Ø 230V
ZHBW076A0 [HM071M U43]				
ZHBW096A0 [HM091M U43]				
ZHBW126A0 [HM121M U33]				
ZHBW146A0 [HM141M U33]	3 Ø / 380-415 V / 50 Hz	Min. : 342 Max. : 457	3	1Ø 230V
ZHBW166A0 [HM161M U33]				
ZHBW128A0 [HM123M U33]				
ZHBW148A0 [HM143M U33]				
ZHBW168A0 [HM163M U33]				

Backup Heater	Power Supply for Heater	
	Phase / Volts / Hz	Capacity (kW)
	AHEH036A [HA031M E1]	1 Ø / 220-240 V / 50 Hz
AHEH066A [HA061M E1]		3+3

[Power Supply for Heat Pump]

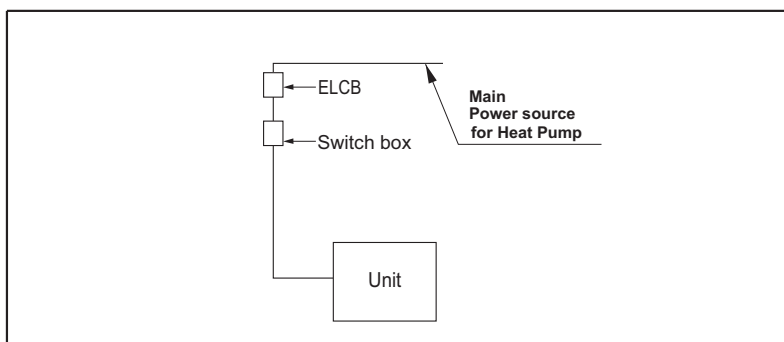

[Power Supply for Backup Heater]

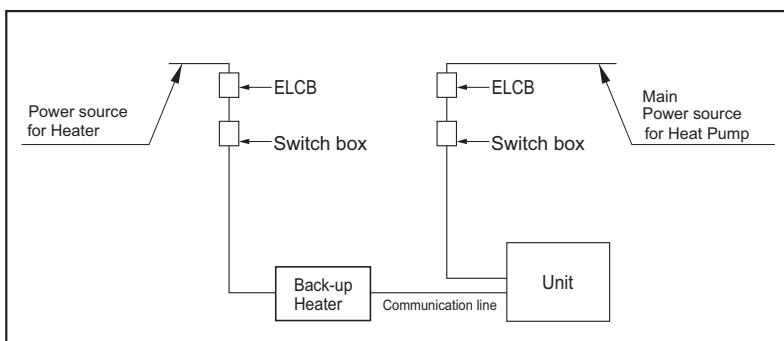

Note

- 1.Voltage supplied to the unit terminals should be within the minimum and maximum range.
- 2.Maximum allowable voltage unbalance between phase is 2%.

8. Operation Range

■ Cooling

Cooling
(Fan coil unit)

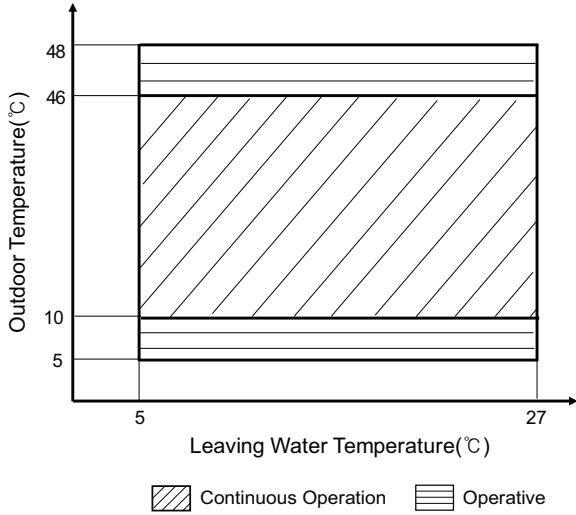

Cooling
(Fan coil unit_Inlet)

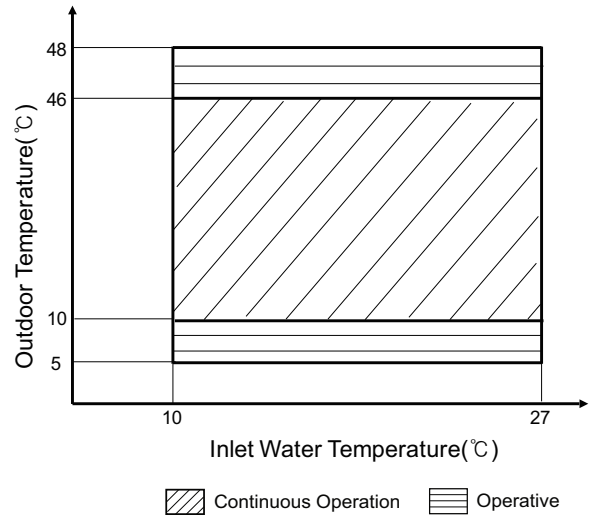

Cooling
(Under floor)

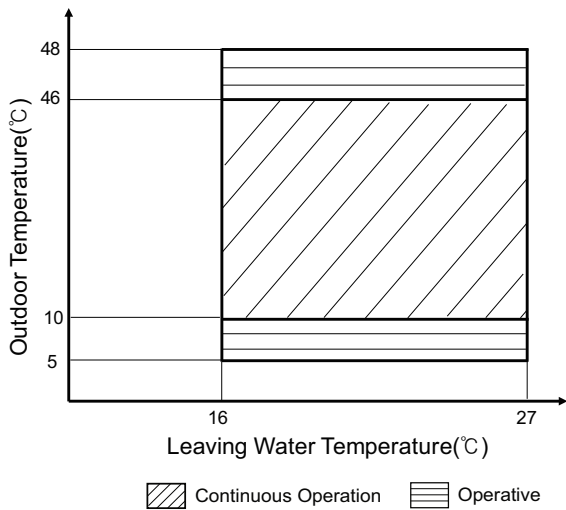

Cooling
(Under floor_Inlet)

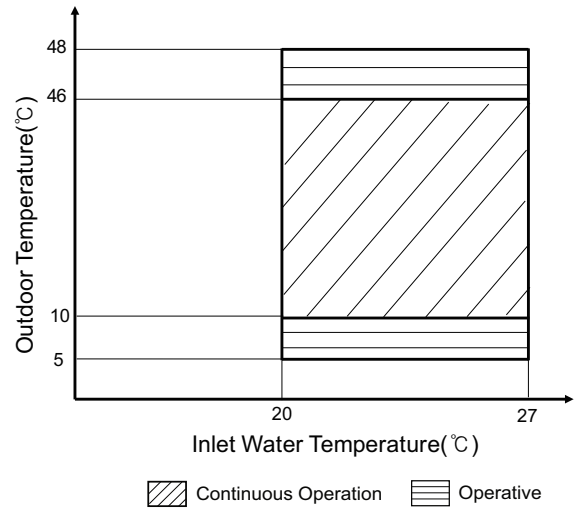

8. Operation Range

■ Heating

Heating

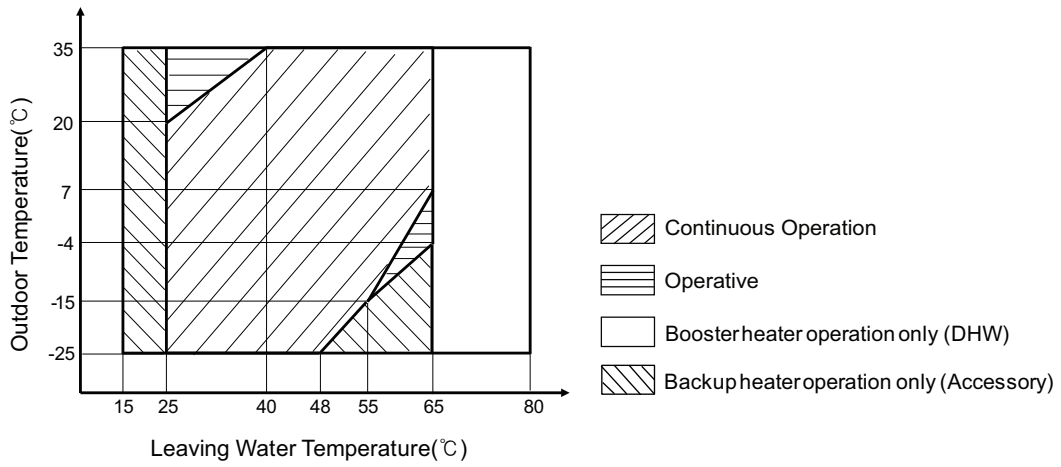

Heating
(Inlet)

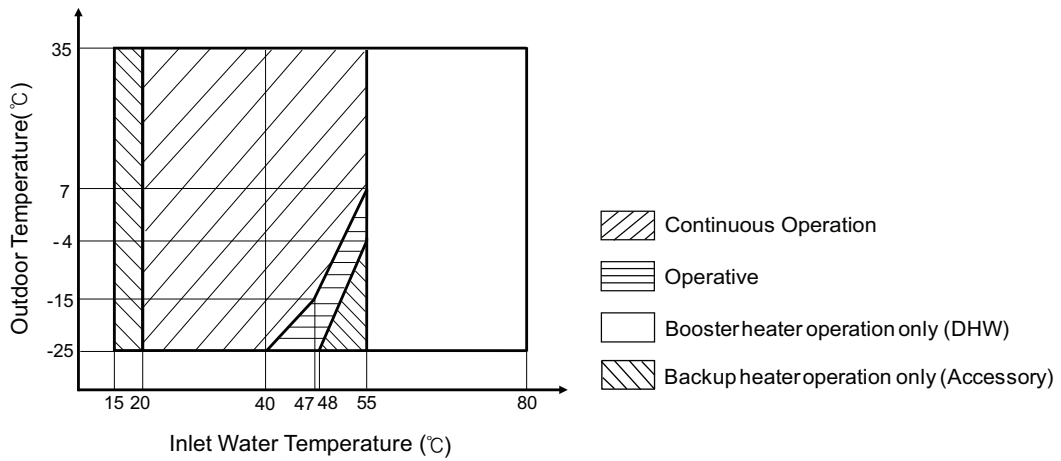

Note

- DHW Heat pump operation : max. 55 °C
- DHW operation with electric heater : max. 80 °C

9. Sound levels

9.1 Sound power level

Note

1. Data is valid at diffuse field condition.
2. Reference acoustic intensity 0dB = 10E-6μW/m²
3. Sound power level is measured on the rated condition in the reverberation rooms. Refer to the Model Specifications for nominal conditions(Power source and Ambient temperature, etc)
4. Sound levels can be increased in accordance with installation and operating conditions. (Operating conditions include some functional condition like Static pressure mode, air guide use, Room target temperature setting, etc and these functions are different in accordance with each model.)
5. Sound level will vary depending on a range of factors such as the construction (acoustic absorption coefficient) of particular room in which the equipment in installed.

Model	Sound Power Level [dB(A)]
	Heating (at rated condition)
ZHBW056A0 [HM051M U43]	60
ZHBW076A0 [HM071M U43]	60
ZHBW096A0 [HM091M U43]	60
ZHBW126A0 [HM121M U33]	63
ZHBW146A0 [HM141M U33]	63
ZHBW166A0 [HM161M U33]	63
ZHBW128A0 [HM123M U33]	63
ZHBW148A0 [HM143M U33]	63
ZHBW168A0 [HM163M U33]	63

ZHBW056A0 [HM051M U43]
ZHBW076A0 [HM071M U43]
ZHBW096A0 [HM091M U43]

ZHBW126A0 [HM121M U33], ZHBW128A0 [HM123M U33]
ZHBW146A0 [HM141M U33], ZHBW148A0 [HM143M U33]
ZHBW166A0 [HM161M U33], ZHBW168A0 [HM163M U33]

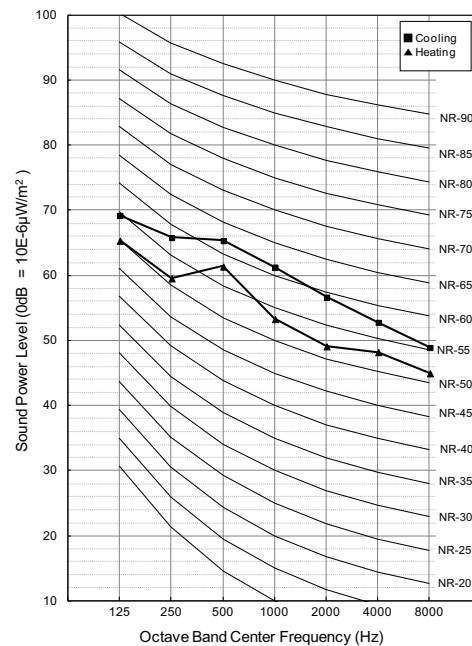
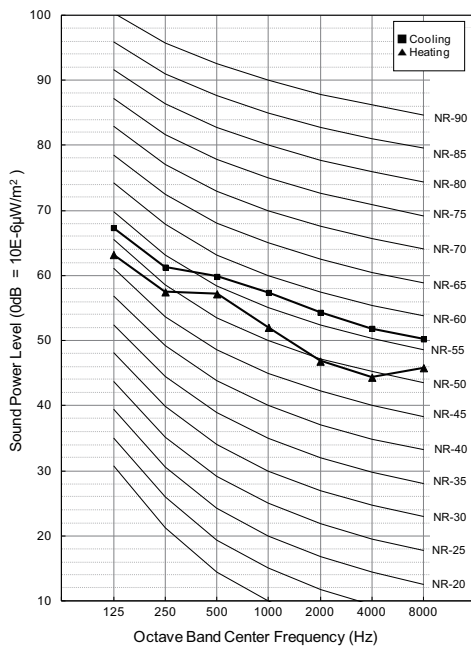

10. Water pump Capacity

The water pump is variable type which is capable to change flow rate, so it may be required to change default water pump capacity in case of noise by water flow. In most case, however, it is strongly recommended to set capacity as Maximum.

■ Pressure Drop

Capacity [kW]	Rated flow-rate [LPM]	Pump Head [m] (at rated flow- rate)	Product pressure drop [m] (Plate heat exchanger)	Serviceable Head [m]
5	14.37	7.5	0.2	7.3
7	20.12	7.3	0.3	7.0
9	25.87	6.1	0.4	5.7
12	34.50	9.8	0.8	9.0
14	40.25	9.3	1.1	8.2
16	46.00	9.0	1.4	7.6

Note

- To secure enough water flow rate, do not set water pump capacity as Minimum. It can lead unexpected flow rate error CH14.
- When installing the product, install additional pump in consideration of the pressure loss and pump performance.
- If flow-rate is low, overloading of product can occur.

THERMA VTM

Monobloc Type

Design and installation

- 1. Alternative Refrigerant R32**
- 2. Select the Best Location**
- 3. Installation Space**
- 4. Water Control**
- 5. Lifting Method**
- 6. Installation**
- 7. Electrical Wiring**
- 8. Starting Operation**

1. Alternative Refrigerant R32

The refrigerant R32 has the higher efficiency and more friendly for environment in comparison with R410A. It has a lower GWP (Global Warming Potential) value, and higher efficiency than R410A. The Ozone Depletion Potential (ODP) of R32 is 0, and Global Warming Potential(GWP) is 675.

Refrigerant piping consists of copper/steel pipes, joints, and other fittings. All components must be selected and installed in conformity with the standards pertaining to the Refrigeration Safety Regulation. Same piping as for R410A can be used.

WARNING

- This product contains fluorinated greenhouse gases (Refrigerant type : R32). Do NOT emit refrigerant gases into the atmosphere.
 - The refrigerant R32 is Slightly Flammable gas. But it does not leak normally. If the refrigerant leaks in the room and contact with burning energy, it may cause fire, or a harmful gas.
 - If there are some leak, turn off any combustible devices, ventilate the room, and contact the dealer from which you purchased the unit. Do not use the unit until the refrigerant leaked is repaired.
 - Only use R32 as refrigerant. Other substances may cause explosions and accidents.
-

CAUTION

- The wall thickness of the piping should comply with the relevant local and national regulations for the designed pressure.
 - For high-pressure refrigerant, any unapproved pipe must not be used.
 - Do not heat pipes more than necessary to prevent them from softening.
-

1. Alternative Refrigerant R32

■ Minimum Floor Area for Installation

- The unit should be installed, operated and stored in a room with a floor area larger than the minimum area. Use the graph of table to determine the minimum area.
- Pipe-work shall be protected from physical damage and shall not be installed in an unventilated space, if that space is smaller than minimum area for installation.

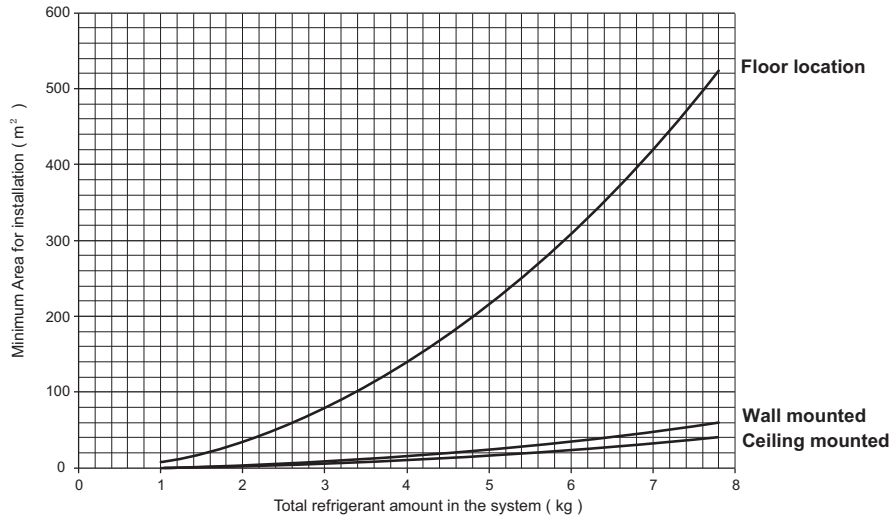

– Total refrigerant amount in the system = factory refrigerant charge + additional refrigerant amount

Refrigerant Amount (kg)	Minimum Area (m ²)		
	Floor location	Wall mounted	Ceiling Mounted
1.0	8.58	0.95	0.64
1.224	12.90	1.43	0.956
1.4	16.82	1.87	1.25
1.6	21.97	2.44	1.63
1.8	27.80	3.09	2.07
2.0	34.32	3.81	2.55
2.2	41.53	4.61	3.09
2.4	49.42	5.49	3.68
2.6	58.00	6.44	4.31
2.8	67.27	7.47	5.00
3.0	77.22	8.58	5.74
3.2	87.86	9.76	6.54
3.4	99.19	11.02	7.38
3.6	111.20	12.36	8.27
3.8	123.90	13.77	9.22
4.0	137.29	15.25	10.21
4.2	151.36	16.82	11.26
4.4	166.12	18.46	12.36
4.6	181.56	20.17	13.50
4.8	197.70	21.97	14.70
5.0	214.51	23.83	15.96
5.2	232.02	25.78	17.26
5.4	250.21	27.80	18.61
5.6	269.09	29.90	20.01
5.8	288.65	32.07	21.47
6.0	308.90	34.32	22.98
6.2	329.84	36.65	24.53
6.4	351.46	39.05	26.14
6.6	373.77	41.53	27.80
6.8	396.76	44.08	29.51
7.0	420.45	46.72	31.27
7.2	444.81	49.42	33.09
7.4	469.87	52.21	34.95
7.6	495.61	55.07	36.86
7.8	522.04	58.00	38.83

2. Select the Best Location

Select space for installing unit, which will meet the following conditions:

- No direct thermal radiation from other heat sources
- No possibility of annoying neighbors by noise from unit
- No exposition to strong wind
- With strength which bears weight of unit
- Note that drain flows out of unit when heating (Heat pump model)
- With space for air passage and service work shown next
- Because of the possibility of fire, do not install unit to the space where generation, inflow, stagnation, and leakage of combustible gas is expected.
- Avoid unit installation in a place where acidic solution and spray (sulfur) are often used.
- Do not use unit under any special environment where oil, steam and sulfuric gas exist.
- It is recommended to fence round the unit in order to prevent any person or animal from accessing the unit.
- If installation site is area of heavy snowfall, then the following directions should be observed.
 - Make the foundation as high as possible.
 - Fit a snow protection hood.
- Select installation location considering following conditions to avoid bad condition when additionally performing defrost operation. (Heat pump model)
 1. Install the unit at a place well ventilated and having a lot of sunshine in case of installing the product at a place with a high humidity in winter (near beach, coast, lake, etc).
(Ex) Rooftop where sunshine always shines.
 2. Performance of heating will be reduced and pre-heat time of the unit may be lengthened in case of installing the unit in winter at following location:
 - 1) Shade position with a narrow space
 - 2) Location with much moisture in neighboring floor.
 - 3) Location with much humidity around.
 - 4) Location where liquid gathers since the floor is not even.
- When installing the unit in a place that is constantly exposed to a strong wind like a coast or on a high story of a building, secure a normal fan operation by using a duct or a wind shield.
 1. Install the unit so that its discharge port faces to the wall of the building. Keep a distance 300 mm or more between the unit and the wall surface.
 2. Supposing the wind direction during the operation season of the unit, install the unit so that the discharge port is set at right angle to the wind direction.

3. Installation Space

3.1 General considerations

- If an awning is built over the unit to prevent direct sunlight or rain exposure, make sure that heat radiation from the condenser is not restricted.
- Ensure that the spaces indicated by arrows around front, back and side of the unit.
- Do not place animals and plants in the path of the warm air.
- Take the unit weight into account and select a place where noise and vibration are minimum.
- Select a place so that the warm air and noise from the unit do not disturb neighbors.
- Place that can sufficiently endure the weight and vibration of the outdoor unit and where even installation is possible.
- Place that has no direct influence of snow or rain.
- Place with no danger of snowfall or icicle drop.
- Place without weak floor or base such as decrepit part of the building or with a lot of snow accumulation.

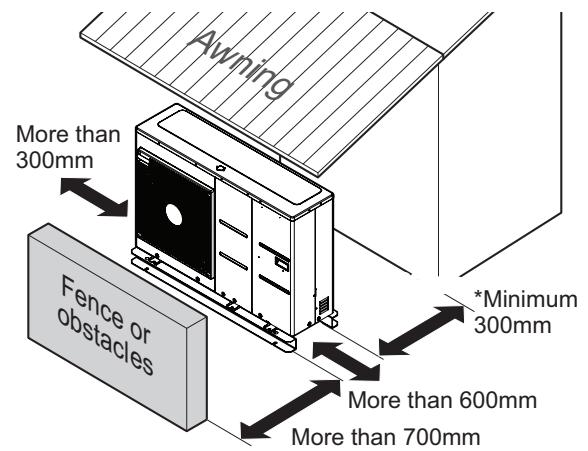

* Please secure the space to install the shut-off valve and strainer.

4. Water Control

4.1 Water quality

Water quality should be complied with EN 98/83 EC Directives.

Detailed water quality condition can be found in EN 98/83 EC Directives.

CAUTION

- If the product is installed at existing hydraulic water loop, it is important to clean hydraulic pipes to remove sludge and scale.
- Installing sludge strainer in the water loop is very important to prevent performance degrade.
- Chemical treatment to prevent rust should be performed by installer.
- It is strongly recommended to install an additional filter on the heating water circuit. Especially to remove metallic particles from the heating piping, it is advised to use a magnetic or cyclone filter, which can remove small particles. Small particles may damage the unit and will NOT be removed by the standard filter of the heat pump system.

4.2 Frost protection

In areas of the country where entering water temperatures drop below 0 °C, the water pipe must be protected by using an approved antifreeze solution. Consult your AWHP unit supplier for locally approved solutions in your area.

Calculate the approximate volume of water in the system. (Except the AWHP unit.) And add the water volume contained in AWHP unit to this total volume.

Antifreeze type	Antifreeze mixing ratio (by volume)					
	0°C	-5°C	-10°C	-15°C	-20°C	-25°C
Ethylene glycol	0%	12%	20%	30%	-	-
Propylene glycol	0%	17%	25%	33%	-	-
Methanol	0%	6%	12%	16%	24%	30%

CAUTION

- Use only one of the above antifreeze.
- If a antifreeze is used, pressure drop and capability degradation of the system can be occurred.
- If one of antifreezes is used, corrosion can be occurred. So please add corrosion inhibitor.
- Please check the concentration of the antifreeze periodically to keep same concentration.
- When the antifreeze is used (for installation or operation), take care to ensure that antifreeze must not be touched.
- Ensure to respect all laws and norms of your country about antifreeze usage.

5. Lifting Method

- When carrying the suspended unit, pass the ropes under the unit and use the two suspension points each at the front and rear.
- Always lift the unit with ropes attached at four points so that impact is not applied to the unit.
- Attach the ropes to the unit at an angle of 40° or less.
- Use only accessories and parts which are of the designated specification when installing.

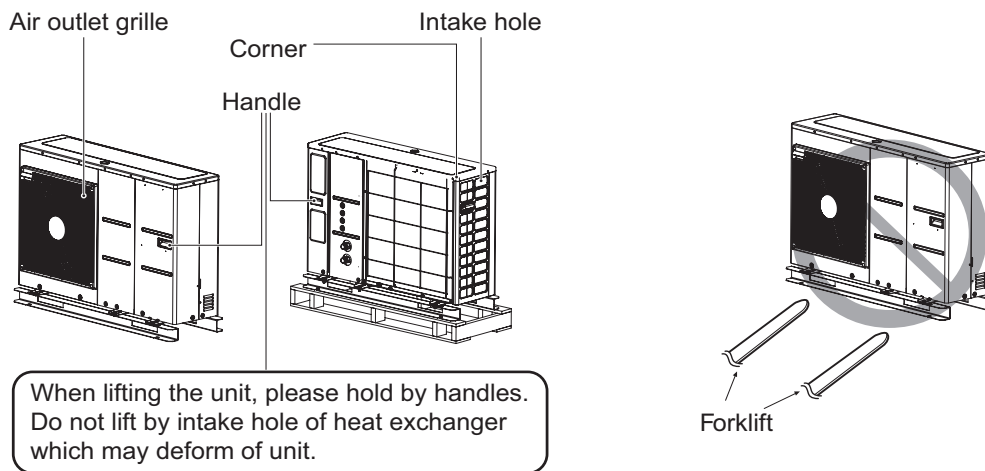
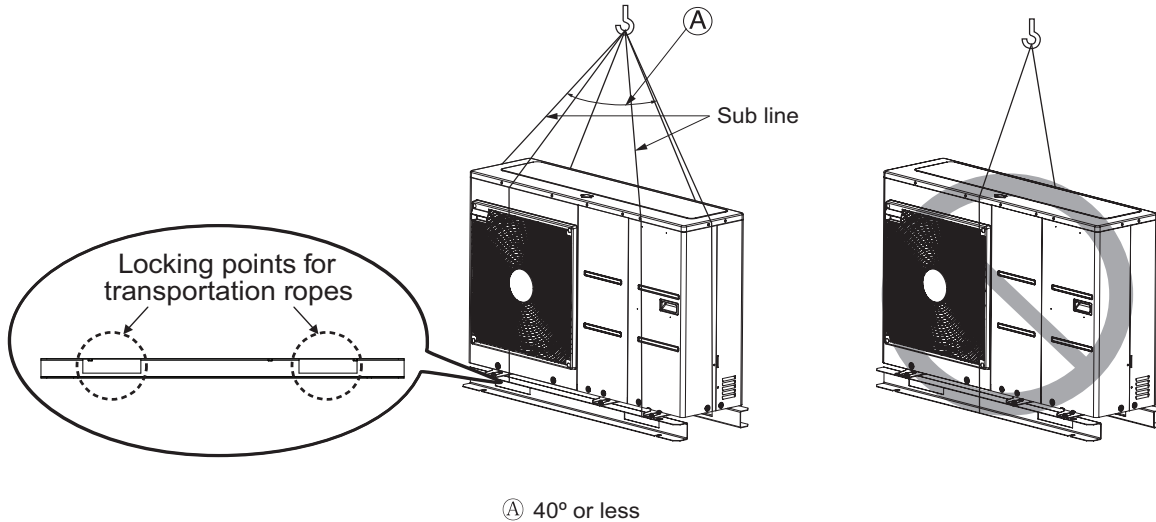

CAUTION

- Do not have only one person carry product if it is more than 20 kg.
- PP bands are used to pack some products. Do not use them as a mean for transportation because they are dangerous.
- Do not touch heat exchanger fins with your bare hands. Otherwise you may get a cut in your hands.
- Tear plastic packaging bag and scrap it so that children cannot play with it. Otherwise plastic packaging bag may suffocate children to death.
- When carrying in Outdoor Unit, be sure to support it at four points. Carrying in and lifting with 3-point support may make Outdoor Unit unstable, resulting in a fall.
- Place extra cloth or bodards in the locations where the casing comes in contact with the sling to prevent damage.
- Hoist the unit making sure it is being lifted at its center of gravity.

6. Installation

6.1 Foundation for Installation

- Check the strength and level of the installation ground so that the unit will not cause any operating vibration or noise after installation.
- Fix the unit securely by means of the foundation bolts.
(Prepare 4 sets of M12 foundation bolts, nuts and washers each which are available on the market.)
- It is best to screw in the foundation bolts until their length are 20mm from the foundation surface.

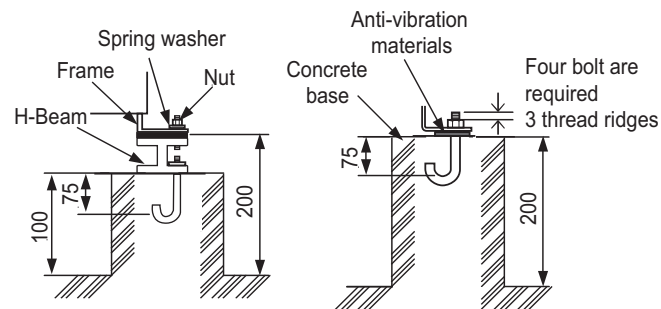
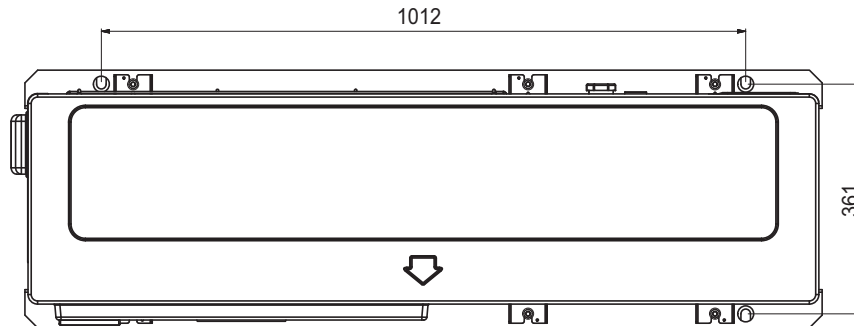

[Unit:mm]

Foundation bolt executing method

WARNING

- Be sure to remove the Pallet (Wood Support) of the bottom side of the outdoor unit Base Pan before fixing the bolt. It may cause the unstable state of the outdoor settlement, and may cause freezing of the heat exchanger resulting in abnormal operations.
- Be sure to remove the Pallet (Wood Support) of the bottom side of the outdoor unit before welding. Not removing Pallet (Wood Support) causes hazard of fire during welding.

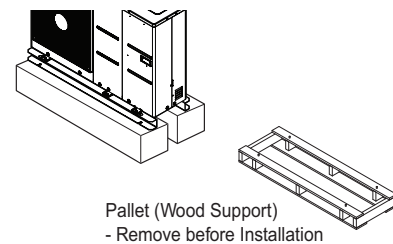

6. Installation

6.2 Water Piping and water Circuit Connection

6.2.1 General considerations

- Followings are should be considered before beginning water circuit connection.
- Service space should be secured.
- Water pipes and connections should be cleaned using water.
- Space for installing external water pump should be provided if internal water pump capacity is not enough for installation field.
- Never connect electric power while proceeding water charging.

6.2.2 Water piping and water circuit connection

1. Definition of terms are as follow :

- Water piping : Installing pipes where water is flowing inside the pipe.
- Water circuit connecting : Making connection between the unit and water pipes or between pipes and pipes. Connecting valves or elbows are, for example, in this category.

Configuration of water circuit is shown in 6.3 Installation Scenes. All connections should be complied with presented diagram.

2. While installing water pipes, followings should be considered :

- While inserting or putting water pipes, close the end of the pipe with pipe cap to avoid dust entering.
- When cutting or welding the pipe, always be careful that inner section of the pipe should not be defective. For example, no weldments or no burrs are found inside the pipe.
- Drain piping should be provided in case of water discharge by the operation of the safety valve. This situation can be happened when the internal pressure is over 3.0 bar and water inside the indoor unit will be discharged to drain hose.

3. While connecting water pipes, followings should be considered :

- Pipe fittings (e.g. L-shape elbow, T-shape tee, diameter reducer, etc) should be tightened strongly to be free from water leakage.
- Connected sections should be leakage-proof treatment by applying tefron tape, rubber bushing, sealant solution, etc.
- Appropriate tools and tooling methods should be applied to prevent mechanical breakage of the connections.
- Operation time of flow control valve(e.g. 3way valve or 2way valve) should be less than 90 seconds.
- Drain hose should be connected with drain piping.

WARNING

• Water condensation on the floor

While cooling operation, it is very important to keep leaving water temperature higher than 16 °C. Otherwise, dewcondensation can be occurred on the floor. If floor is in humid environment, do not set leaving water temperature below 18 °C.

• Water condensation on the radiator

While cooling operation, cold water may not flow to the radiator. If cold water enters to the radiator, dew generation on the surface of the radiator can be occurred.

• Drainage treatment

While cooling operation, condensed dew can drop down to the bottom of the unit. In this case, prepare drainagetreatment (for example, vessel to contain condensed dew) to avoid water drop.

• Shutoff Valve

- While assembling two shut-off valves, that are found inside 'AWHP Installation Kit', pop sound will be heard when valve is open or close by rotating handles. It is normal condition because the sound is due

6. Installation

to leakage of charged nitrogen gas inside the valve. The nitrogen gas is applied to secure quality assurance.

- Before starting water charging, these two shut-off valves should be assembled with water inlet and outlet pipe of the indoor unit.
-

6. Installation

6.3 Installation Scenes

If installed with pre-existing boiler, the boiler and THERMA V should not be operated together. If entering water temperature of THERMA V is above 57 °C, the system will stop operation to prevent mechanical damage of the unit. For detailed electric wiring and water piping, please contact authorized installer.

Some installation scenes are presented for example. As these scenes are conceptual figures, installer should optimize the installation scene according to the installation conditions.

◆ CASE 1 : Connecting Heat Emitters for Heating and Cooling

(Under floor loop, Fan coil unit and Radiator)

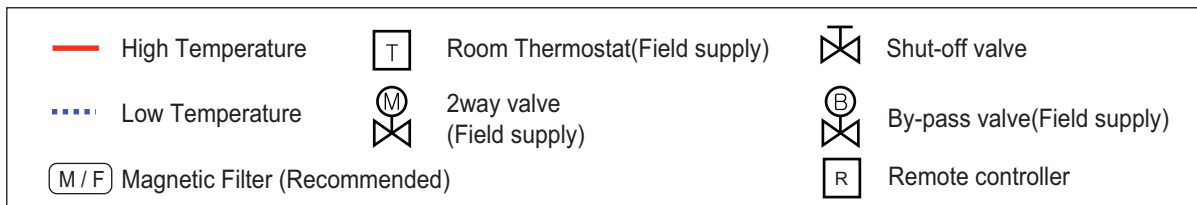
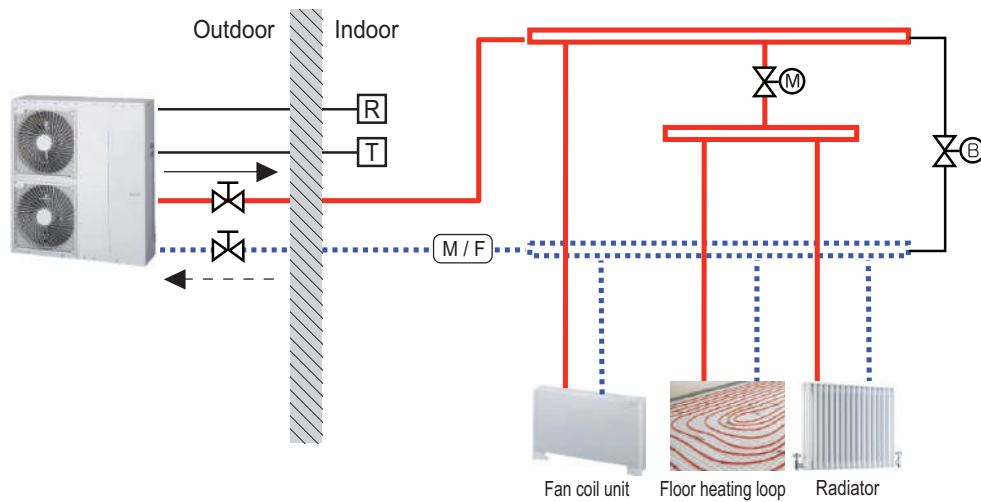

6. Installation

◆ CASE 2 : Connecting DHW Tank

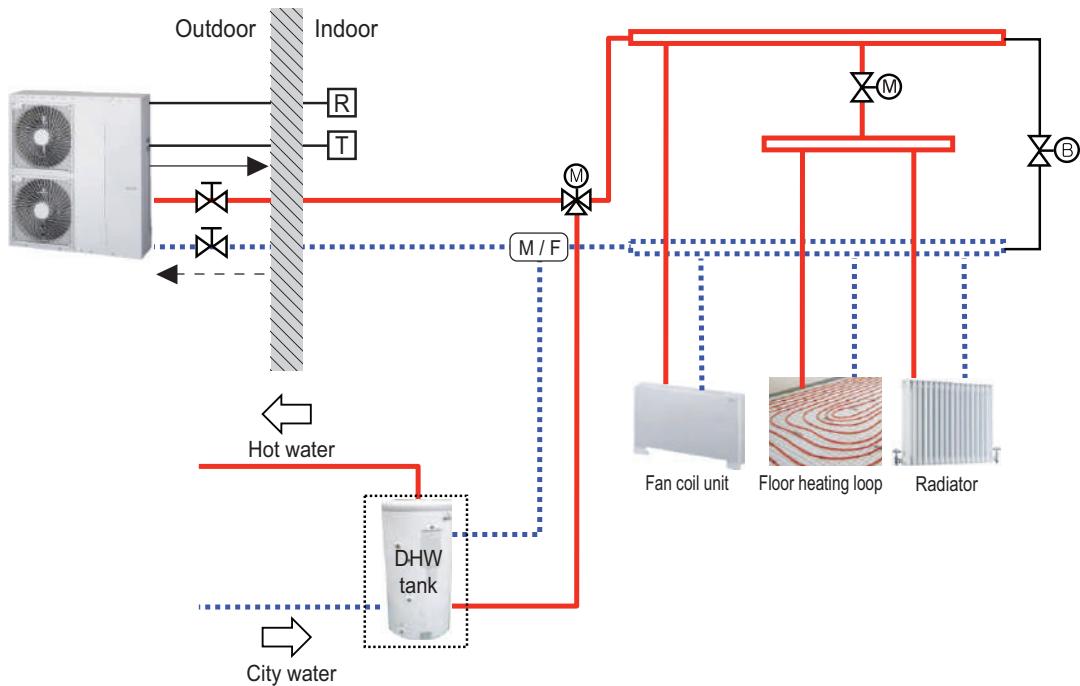

◆ CASE 3 : Connecting Solar thermal system

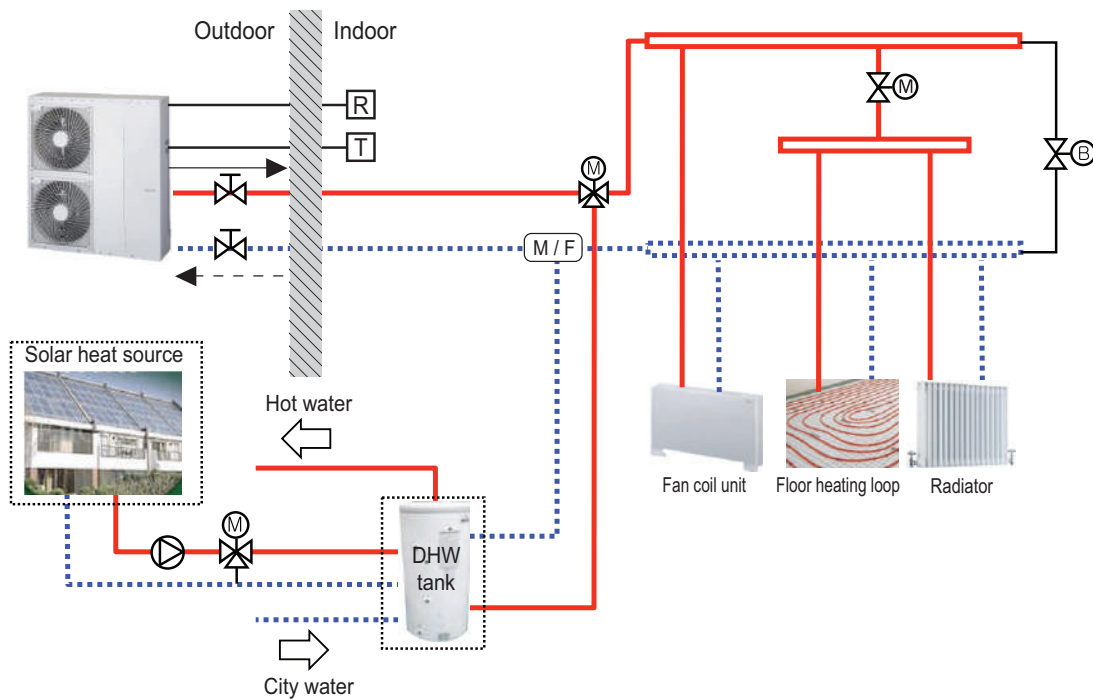

— High Temperature	Room Thermostat (Field supply)	Remote controller
⋯ Low Temperature	2way valve (Field supply)	3way valve (Field supply)
Shut-off valve	By-pass valve (Field supply)	Pump (Field supply)
Magnetic Filter (Recommended)		

6. Installation

◆ CASE 4 : Connecting 2nd Circuit

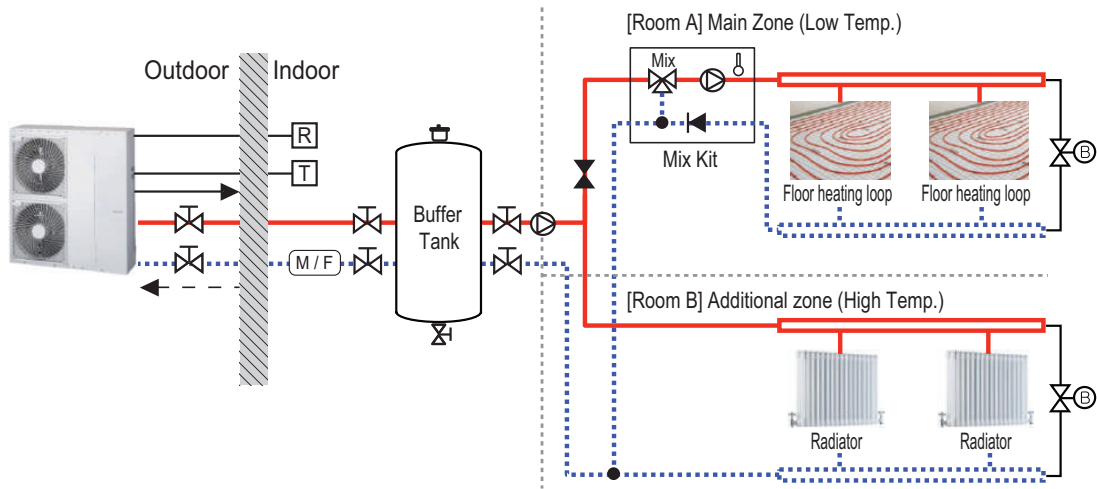

◆ CASE 5 : Connecting 3rd Party

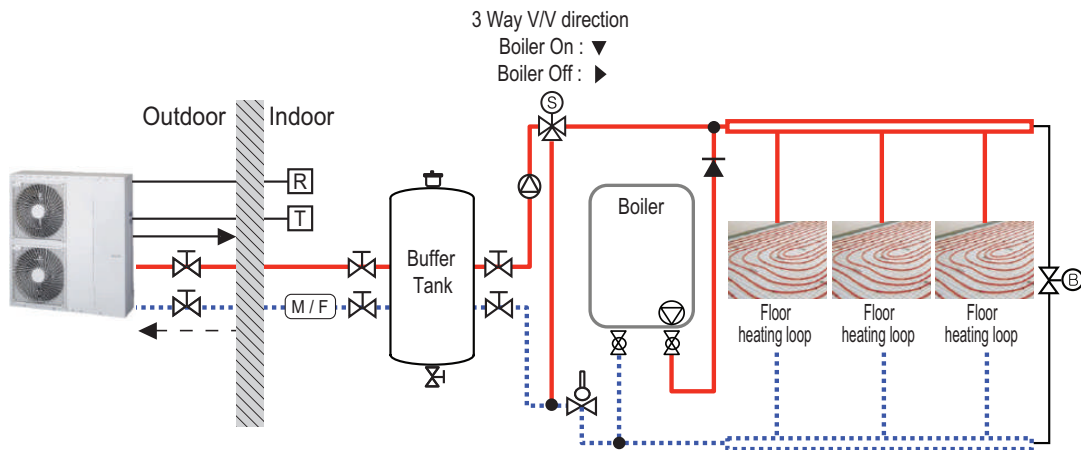

High Temperature	Room Thermostat(Field supply)	3way valve (Field supply)
Low Temperature	2way valve (Field supply)	Pump(Field supply)
Shut-off valve	By-pass valve(Field supply)	Mix Kit (Field supply)
Magnetic Filter (Recommended)	Air vent (Field supply)	Aquastat V/V
Pressure Regulation valve (Field supply)		

6. Installation

6.4 Water charging

For water charging, please follow below procedures.

• **Step 1**

Open all valves of whole water circuit. Supplied water should be charged not only inside the indoor unit, but also in the under floor water circuit, sanitary water tank circuit, FCU water circuit, and any other water circuits controlled by the product.

• **Step 2**

Connect supply water into drain valve and fill valve located at the side of the shut-off valve.

⚠ CAUTION

- **No water-leakage permitted at the drain and fill valve. Leakage-proof treatment which is described in previous section should be applied**

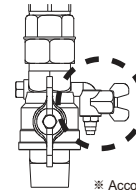

* According to each model, shut off valve external appearance, direction, location etc could be different slightly.

• **Step 3**

Start to supply water. While supplying water, following should be kept.

- Pressure of supplying water should be 2.0 bar approximately.
- For supplying water pressure, time to be taken from 0 bar to 2.0 bar should be more than 1 minute. Sudden water supply can yield water drain through safety valve.
- Fully open the cap of air vent to assure air purging. If air is exist inside the water circuit, then performance degrade, noise at the water pipe, mechanical damage at the surface of electric heater coil.

• **Step 4**

Stop water supplying when the pressure gage located in front of the control panel indicates 2.0 bar.

• **Step 5**

Close drain valve and fill valve. Then wait for 20~30 seconds to observe water pressure being stabilized.

• **Step 6**

If following conditions are satisfactory, then go to step 7(pipe insulation). Otherwise, go to step 3.

- Pressure gage indicates 2.0 bar. Note that sometimes pressure in decreased after step 5 due to water charging inside expansion vessel.
- No air purging sound is heard or no water drop are popping out from air vent.

• **Step 7 (Pipe Insulation)**

Purpose of water pipe insulation is :

- To prevent heat loss to external environment
- To prevent dew generation on the surface of the pipe in cooling operation

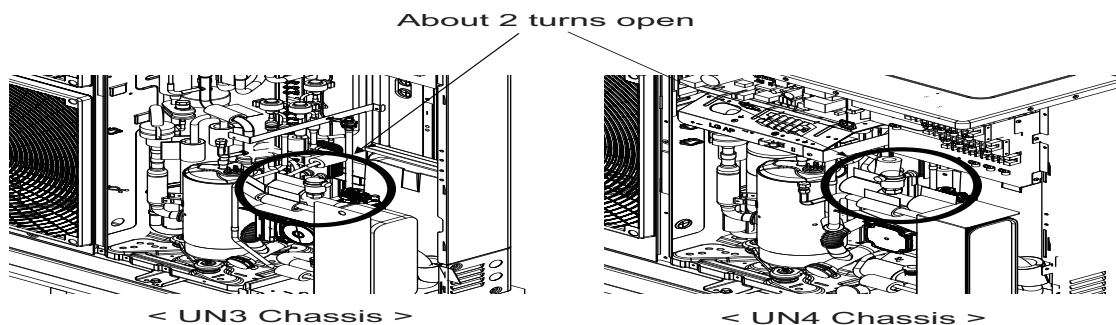

6. Installation

6.5 Evacuating

To remove air and recover refrigerant system when leaking the piping system.

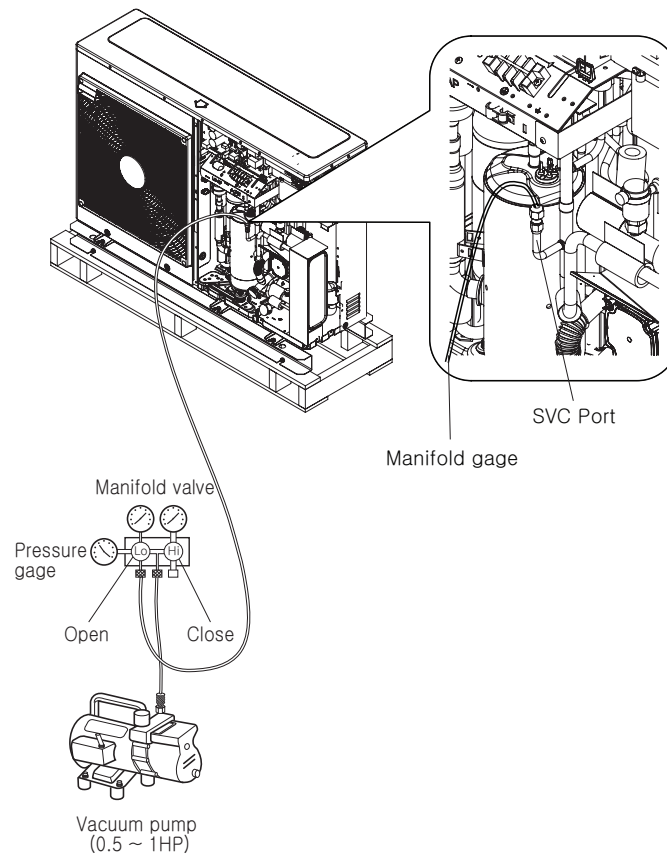

- When selecting a vacuum, you should select one which is capable of achieving 0.2 Torr of ultimate vacuum.
- Degree of vacuum is expressed in Torr, micron, mmHg, and Pascal (Pa). The units correlate as follows:

	Unit	Standard atmospheric pressure	Perfect vacuum
Gage Pressure	Pa	0	-1.033
Absolute Pressure	Pa	1.033	0
Torr	Torr	760	0
Micron	Micron	760000	0
mmHg	mmHg	0	760
Pa	Pa	1013.33	0

6. Installation

6.6 Charge of refrigerant

Refrigerant to be charged after evacuating process.

Check out the amount of refrigerant on the name plate.

Be sure that charging at cooling mode in case of charging insufficiently.

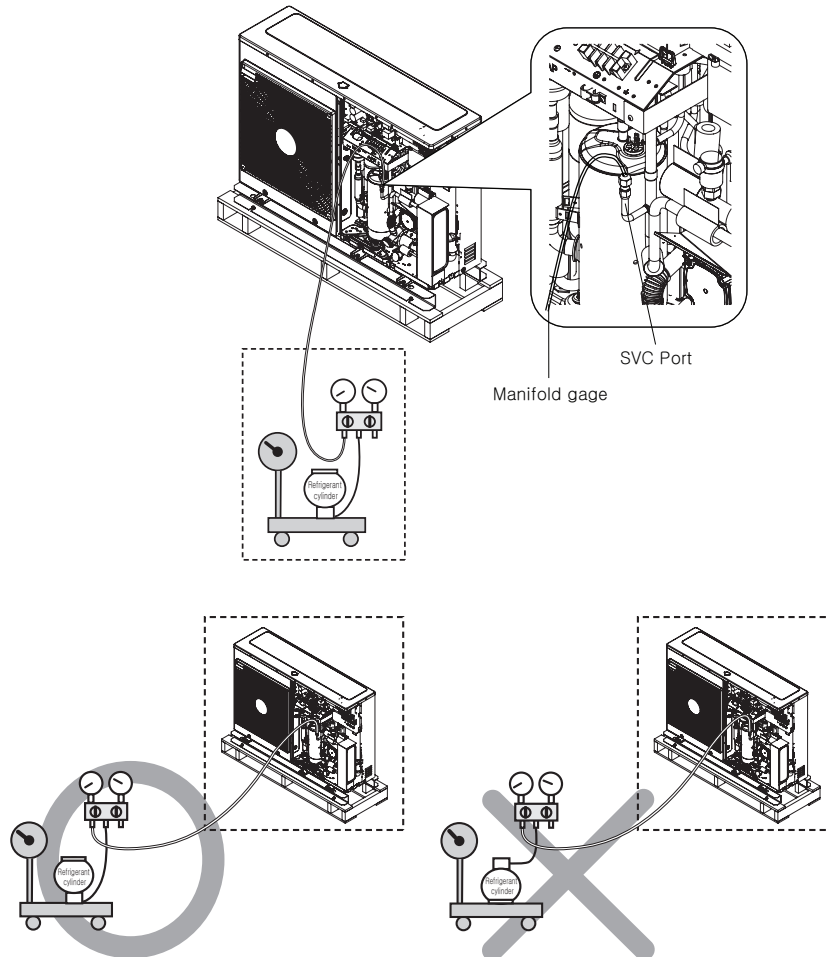

7. Electrical Wiring

7.1 Caution

1. Follow ordinance of your governmental organization for technical standard related to electrical equipment, wiring regulations and guidance of each electric power company.
-

WARNING

- **Be sure to have authorized electrical engineers do the electric work using special circuits in accordance with regulations and this installation manual. If power supply circuit has a lack of capacity or electric work deficiency, it may cause an electric shock or fire.**
-
2. Install the Outdoor Unit communication line away from the power source wiring so that it is not affected by electric noise from the power source. (Do not run it through the same conduit.)
 3. Be sure to provide designated grounding work to Outdoor Unit.
-

CAUTION

- **Be sure to correct the outdoor unit to earth. Do not connect earth line to any gas pipe, liquid pipe, lightning rod or telephone earth line. If earth is incomplete, it may cause an electric shock.**
-
4. Give some allowance to wiring for electrical part box of Indoor and Outdoor Units, because the box is sometimes removed at the time of service work.
 5. Never connect the main power source to terminal block of communication line. If connected, electrical parts will be burnt out.
 6. Only the communication line specified should be connected to the terminal block for Outdoor Unit communication.
-

CAUTION

- **This product have reversed phase protection detector that only works when the power is turned on. If there exists black out or the power goes on and off which the product is operating, attach a reversed phase protection circuit locally. running the product in reversed phase may break the compressor and other parts.**
 - **Use the 2-core shield cables for communication lines. Never use them together with power cables.**
 - **The conductive shielding layer of cable should be grounded to the metal part of both units.**
 - **Never use multi-core cable**
 - **As this unit is equipped with an inverter, to install a phase leading capacitor not only will deteriorate power factor improvement effect, but also may cause capacitor abnormal heating. Therefore, never install a phase leading capacitor.**
 - **Make sure that the power unbalance ratio is not greater than 2%. If it is greater, the unit's lifespan will be reduced.**
 - **Introducing with a missing N-phase or with a mistaken N-phase will break the equipment.**
-

7. Electrical Wiring

■ Power Cable Specification

The power cord connected to the outdoor unit should be complied with IEC 60245 or HD 22.4 S4 (Rubber insulated cord, type 60245 IEC 66 or H07RN-F)



If the supply cord is damaged, it must be replaced by the manufacturer, its service agent or similarly qualified persons in order to avoid a hazard.

■ Precautions when laying power wiring

Use round pressure terminals for connections to the power terminal block.

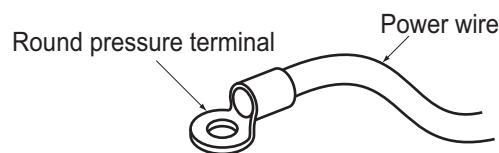

When none are available, follow the instructions below.

- Do not connect wiring of different thicknesses to the power terminal block. (Slack in the power wiring may cause abnormal heat.)
- When connecting wiring which is the same thickness, do as shown in the figure below.

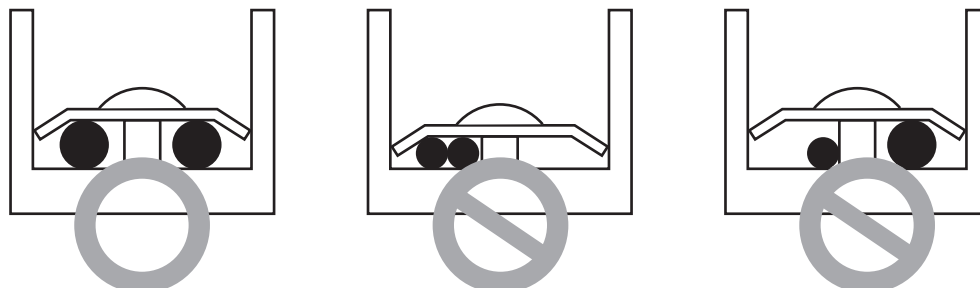

- For wiring, use the designated power wire and connect firmly, then secure to prevent outside pressure being exerted on the terminal block.
- Use an appropriate screwdriver for tightening the terminal screws. A screwdriver with a small head will strip the head and make proper tightening impossible.
- Over-tightening the terminal screws may break them.

⚠ CAUTION

- When the 400 volt power supply is applied to “N” phase by mistake, replace inverter PCB and transformer in control box.

■ Connecting Cable Specification

The connecting cable, being used to connect the indoor unit and outdoor unit, should be complied with IEC 60335-1 standard (This equipment shall be provided with a cord set complying with the national regulation).

If the supply cable is damaged, it must be replaced by a special cable or assembly available from the manufacturer or its service agent.

7. Electrical Wiring

7.2 Wiring Procedure for Power Cable and Connecting Cable

1. Disassemble the side panel and front panel from the unit by loosening screws.
2. Connect Power cable to Main Power Terminal.
See below figure for detailed information. When connecting earth cable, the diameter of cable should refer to the below table. The earth cable is connected to the Control box case where earth symbol is \oplus marked.
3. Use cable clamps (or cord clamps) to prevent unintended move of Power cable.
4. Reassemble the side panel to the unit by fastening screws.

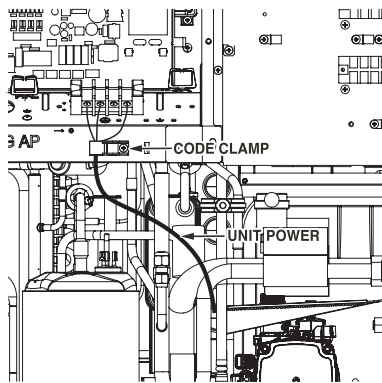

1Ø : 5kW, 7kW, 9kW

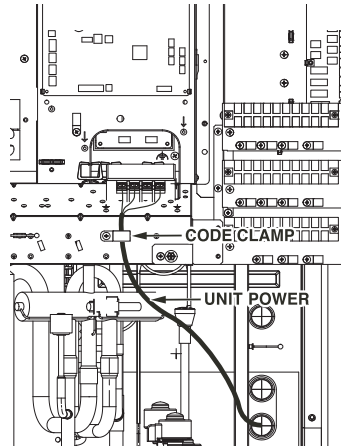

1Ø : 12kW, 14kW, 16kW

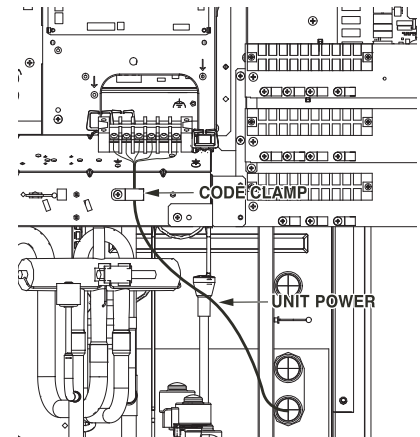

3Ø : 12kW, 14kW, 16kW

Failure to do these instructions can result in fire, electric shock or death.

- Make sure the power cable does not touch the copper tube.
- Make sure to fix [cord clamp] firmly to sustain the connection of terminal.
- Make sure to connect unit power & heater power separately.

7. Electrical Wiring

7.3 Dip switch information

Turn off electric power supply before setting DIP switch





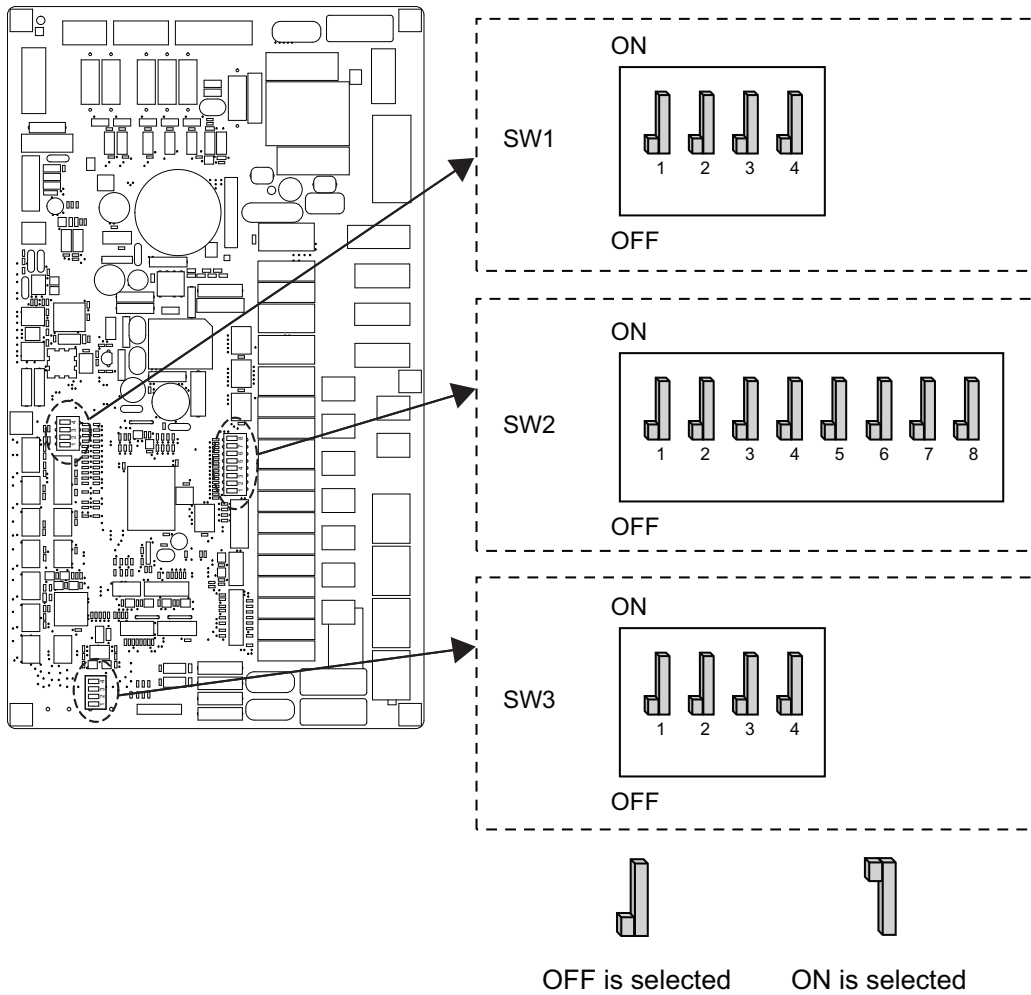







- Whenever adjusting DIP switch, turn off electric power supply to avoid electric shock.

■ Indoor PCB















7. Electrical Wiring

◆ Option Switch 1

































Description	Setting	Default
MODBUS	1  As Master	1 
	1  As Slave	
MODBUS Function	2  Common 3 rd party	2 
	2  SIEMENS	
Reserved	  3 3 Reserved	3 
Reserved	  4 4 Reserved	4 

◆ Option Switch 3

Description	Setting	Default
Remote Air Sensor	1  Remote sensor is not installed	1 
	1  Remote sensor is installed	
Antifreeze	2  Antifreeze mode not use	2 
	2  Antifreeze mode	
Reserved	  3 3 Reserved	3 
Reserved	  4 4 Not Use	4 

7. Electrical Wiring

◆ Option Switch 2

Description	Setting	Default
Role when central controller is equipped	1  As Master	1 
	1  As Slave	
Accessory installation information	  Unit + Outdoor unit is installed 2 3	2  3 
	  Unit + Outdoor unit + DHW tank is installed 2 3	
	  Unit + Outdoor unit + DHW tank + Solar thermal system is installed 2 3	
	  DHW tank is installed 2 3	
Cycle	4  Heating Only	4 
	4  Heating & Cooling	
Flow Switch Detection	5  Always	5 
	5  While water pump is on	
Selecting Backup Heater capacity	  Backup Heater is not used 6 7	6  7 
	  1Ø model : Half capacity is used 3Ø model : 1/3 capacity is used 6 7	
	  Unused 6 7	
	  Full capacity is used 6 7	
Thermostat installation information	8  Thermostat is NOT installed	8 
	8  Thermostat is installed	

7. Electrical Wiring

Outdoor PCB

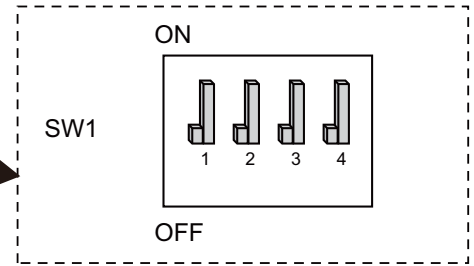
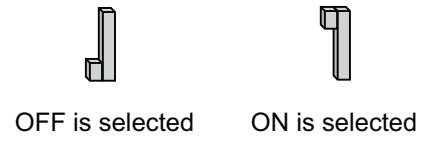
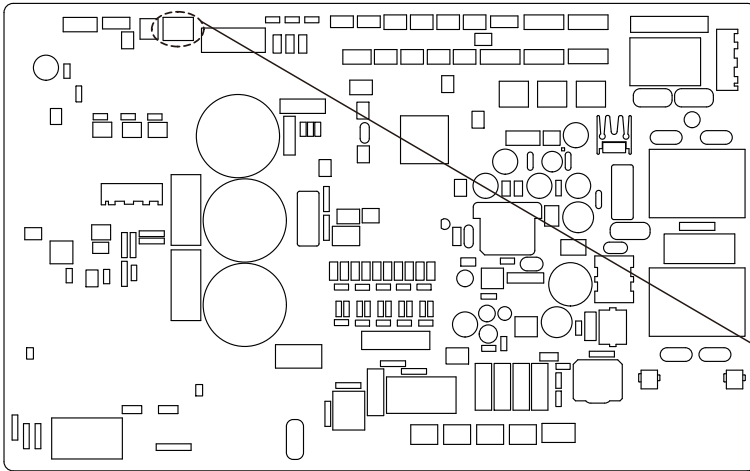

UN4 Chassis

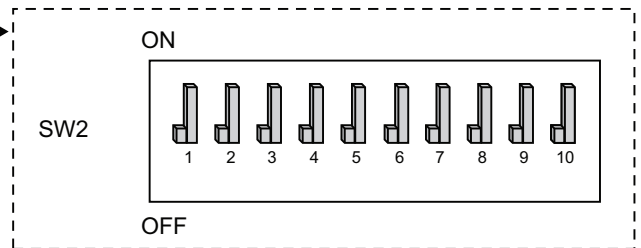
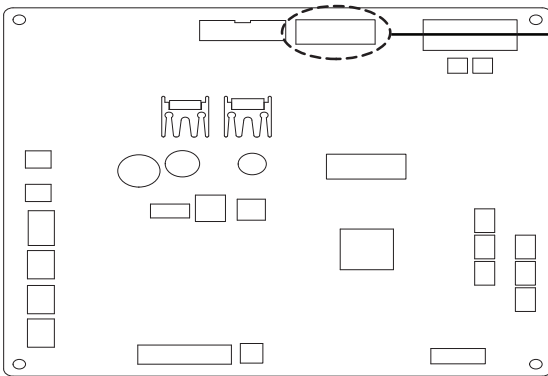

UN3 Chassis



Peak Control

Description	Setting	Default
Peak Control	3  Max Mode	3 
	3  Peak Control	

8. Starting Operation

- Before starting operation, pre-check points are described in this chapter.

8.1 Starting Operation flow chart

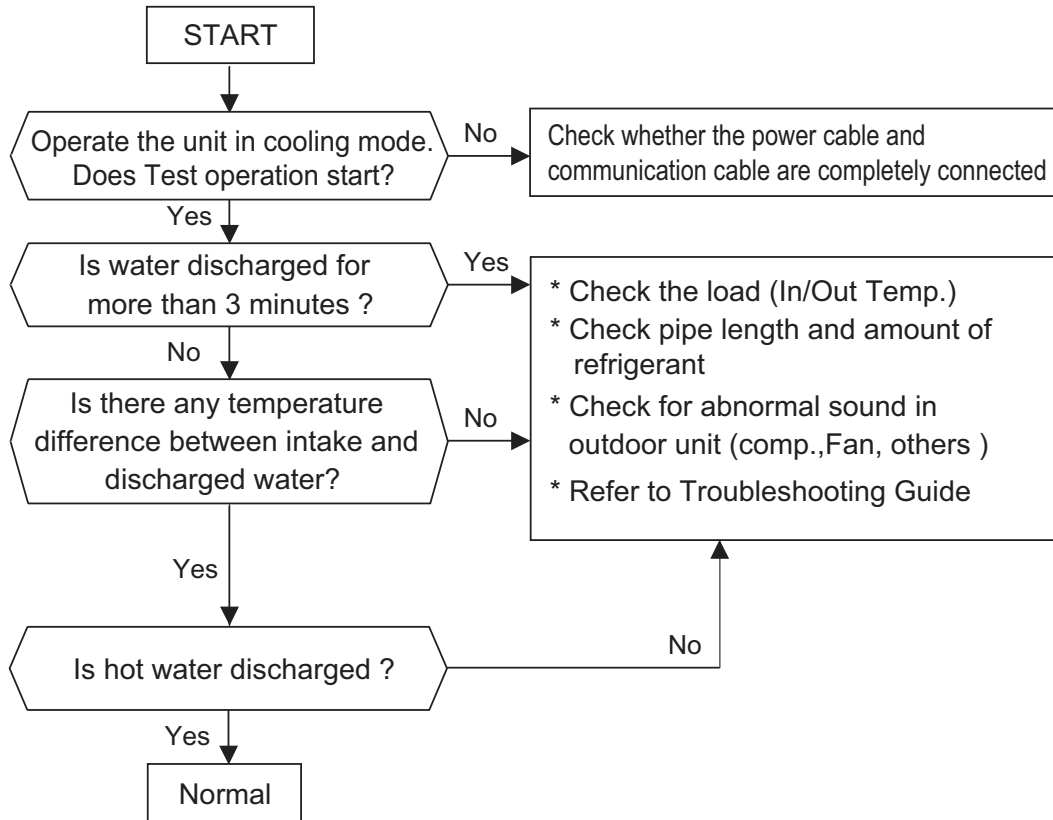

8. Starting Operation

8.2 Check List before Starting Operation

Turn off the power before changing wiring or handling unit.

No.	Category	Item	CheckPoint
1	Electricity	Field wiring	<ul style="list-style-type: none"> All switches having contacts for different poles should be wired tightly according to regional or national legislation. Only qualified person can proceed wiring. Wiring and local-supplied electric parts should be complied with European and regional regulations. Wiring should be following the wiring diagram supplied with the product.
2		Protective devices	<ul style="list-style-type: none"> Install ELB (earth leakage breaker) with 30mA. ELB inside the control box of the unit should be turned on before starting operation.
3		Earth wiring	<ul style="list-style-type: none"> Earth should be connected. Do not earth to gas or city water pipe, metallic section of a building, surge absorber, etc.
4		Power supply	<ul style="list-style-type: none"> Use dedicated power line.
5		Terminal block wiring	<ul style="list-style-type: none"> Connections on the terminal block (inside the control box of the unit) should be tightened.
6	Water	Charged water pressure	<ul style="list-style-type: none"> After water charging, the pressure gage (in front of the unit) should indicate 2.0~2.5 barG. Do not exceed 3.0 barG.
7		Air purge	<ul style="list-style-type: none"> During water charging, air should be taken out through the hole of the air purge. If water does not splash out when the tip (at the top of the hole) is pressed, then air purging is not completed yet. If well purged, the water will splash out like fountain. Be careful when testing air purge. Splashed water may make your dress wet.
8		Shut-off valve	<ul style="list-style-type: none"> Two shut-off valves (located at the end of water inlet pipe and water outlet pipe of the unit) should be open.
9		By-pass valve	<ul style="list-style-type: none"> By-pass valve should be installed and adjusted to secure enough water flow rate. If water flow rate is low, flow switch error (CH14) can be occurred.
10	Product Installation	Hang to the wall	<ul style="list-style-type: none"> As the unit is hung on the wall, vibration or noise can be heard if the unit is not fixed tightly. If the unit is not fixed tightly, it can fall down during operation.
11		Parts inspection	<ul style="list-style-type: none"> There should be no apparently damaged parts inside the unit.
12		Refrigerant leakage	<ul style="list-style-type: none"> Refrigerant leakage degrades the performance. If leakage found, contact qualified LG air conditioning installation person.
13		Drainage treatment	<ul style="list-style-type: none"> While cooling operation, condensed dew can drop down to the bottom of the unit. In this case, prepare drainage treatment (for example, vessel to contain condensed dew) to avoid water drop.

8. Starting Operation

8.3 Maintenance

To assure best performance of **THERMA V**, it is required to perform periodical check and maintenance. It is recommended to proceed following check list for once a year.

Turn off the power before proceeding maintenance

No.	Category	Item	Check Point
1	Water	Water pressure	<ul style="list-style-type: none"> In normal state, the pressure gage (in front of the indoor unit) should indicate 2.0~2.5 barG. If the pressure is less than 0.3 barG, please recharge the water.
2		Strainer (Water filter)	<ul style="list-style-type: none"> Close the shut-off valves and disassemble strainer. Then wash the strainer to make it clean. While disassembling the strainer, be careful for water flood out.
3		Safety valve	<ul style="list-style-type: none"> Open the switch of the safety valve and check if water is flood out through the drain hose. After checking, close the safety valve.
4	Electricity	Terminal block wiring	<ul style="list-style-type: none"> Look and inspect if there is loosen or defected connection on the terminal block.

8.4 Check before Starting Operation

1	Check to see whether there is any refrigerant leakage, and check whether the power or transmission cable is connected properly.
2	<p>Confirm that 500 V megger shows 2.0 MΩ or more between power supply terminal block and ground. Do not operate in the case of 2.0 MΩ or less.</p> <p>Note Never carry out mega ohm check over terminal control board. Otherwise the control board may break.</p> <p>Immediately after mounting the unit or after leaving it turned off for an extended length of time, the resistance of the insulation between the power supply terminal board and the ground may decrease to approx. 2.0 MΩ as a result of refrigerant accumulation in the internal compressor.</p> <p>If the insulation resistance is less than 2.0 MΩ, turn on the main power supply.</p>



Air Solution

LG Electronics Inc, 128, Yeoui-daero,
Yeongdeungpo-gu, Seoul, Korea
(07336)
<http://partner.lge.com>

Copyright © 2018 LG Electronics Inc.
All Rights Reserved.
Printed in Korea July / 2018

The air conditioners manufactured by LG have received ISO9001 certificate for quality assurance and ISO14001 certificate for environmental management system.
The specifications, designs, and information in this brochure are subject to change without notice.